

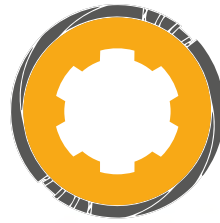

SCANDREA IMPLANT SYSTEM







SCANDREA

SCANDREA +

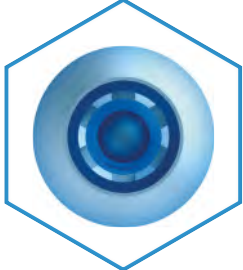

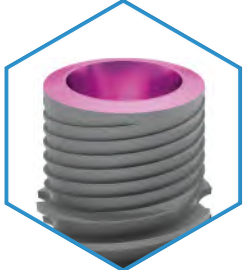
TABLE OF CONTENTS

INTRODUCTION	3	
About the company	3	
Technology and quality	4	
Implant surface finish	6	
Packaging	8	
SCANDREA IMPLANT SYSTEM	12	
The functional structures of the system elements	15	
The applicational fields of Scandrea System	16	
Ø 3.3 mm implant diameter	18	
Ø 3.8 mm implant diameter	20	
Ø 4.3 mm implant diameter	22	
Ø 5.0 mm implant diameter	24	
Ø 6.0 mm implant diameter	26	
Ø 7.0 mm implant diameter	28	
SCANDREA ABUTMENT SYSTEM	30	
Accessories of abutments	38	
INSTRUMENTS	40	
Instrument Kits	44	
Surgical drills	46	
Ratchet torque wrench	48	



About the company

BIONIKA Medline Orvostechnikai Kft. Is a member of the Hungarian-Swedish group of companies. The predecessor of it was founded in 1989. The owners of the company are Hungarian and Swedish citizens. We have more than 30-year-experience in the field of medical instruments and implant development, production and trade.

BIONIKA as a researcher, developer, manufacturer and distributor is present in dentistry, oral surgery, traumatology, orthopedics and rehabilitation in the medical-professional areas.

According to our objective and perception, we attach great importance to the word „BIONIKA”, which marks a scientific thinking on the boundaries of biology, technology and electronics that combines these three areas in our researching and developing work.

Clinical and technological experiences: The continuous process, combination and utilization of clinical and technological experiences in development contributes to our success, up to the production base. Here you will find the best solutions and constructions suited to customer needs, which are under continuous development.

Development: The owners of BIONIKA put great emphasis on continuous product and technological research and development. Our products are developed in close collaboration with doctors and engineers, enabling us to ensure the world-class quality and practical utilization.

Quality: The quality of the products expected by our customers is guaranteed by design, manufacturing and quality management according to the harmonized European Union laws. The BIONIKA Medline Kft. is operated according to the EN ISO 9001 and the EN ISO 13485 quality management system. Our products are provided with CE marks.

Guarantee: After inserting the implant - the risk of the ossification process is assumed by BIONIKA, independently of cause and effect relationship – exchange guarantee is ensured within one year after the purchase. Otherwise, we provide a long-term, 10-year guarantee for our products.



DENTISTRY

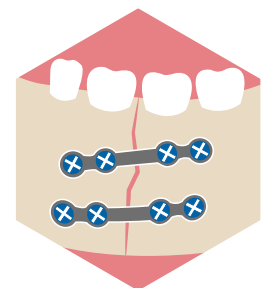

ORAL SURGERY



TRAUMATOLOGY



ORTHOPEDICS

Technology

BIONIKA Medline Kft. has more than 30 years of experience in the development and production of dental implants, dental insertion instruments and stomatological parts. During this time more than 40 types of implant systems have been developed and are being manufactured to date, including insertion instruments.

Some of these parts have been developed for their own marketing in accordance with their own market needs. Other systems - in cooperation with independent medical groups - are made to order, mainly developed and manufactured for foreign markets. (These are sold by the customers under their own brand name).

Our partners can choose from approximately 20.000 different parts of different sizes and shapes. Our manufacturing technology is flexible, we can quickly move from one component to another, and we are able to fulfill thousands of orders with a short turnaround time.

This area requires high precision production (in some cases it is necessary to hold 2-5µm tolerances). All the technological operations we carry out are from manufacturing, surface design, packaging. Our products are

CE marked and the production process is under strict quality management system.

Biocompatible materials are the most important raw materials for dental, oral surgery, traumatology and orthopedic medical implants.

Because relatively small series of customized solutions are required, they require fast programmable CNC machining technology. Accordingly, we have molded CNC machining centers and Swiss type longitudinal machining centers. For machining more complex surfaces, an industrial 5-axis CNC center is used with CAD-CAM system support. Our machines are equipped not only with fixed, but also with propelled cutting instrument units, with which we can perform more complex spatial geometrical machining.

As a complementary technology, we have sandblasting, polishing titanium coloring and sterilization equipments.

The production of custom prosthetic components for dental applications is supported by the BIONIKA Milling center.

Our Partners

The 'Our Partners' section features a collection of logos for various organizations. The logos are arranged in several rows. The first row includes HUNGARODENTAL (with a large 'HD' logo), a circular logo for 'HUNGARODENTÁRIUM IMPLANTOLÓGIAI TUDOSÍTÓK BÍRSÓVA', and CITIZEN. The second row contains SIEMENS, SAASCO (with 'medical devices' and 'Med' text), and phv (with 'PHARMAVALID Kft.' text). The third row shows FRESH-DENTAL, OGYÉI (Országos Gyógyszerészeti és Élelmezés-egészségügyi Intézet), and a gear logo with 'ME'. The fourth row includes formlabs, bay, graphIT, NCT (CONTROL DRIVES MOTORS KEEP MOVING), EIJKI (MSZ EN ISO 9001:2009, MSZ EN ISO 13485:2004), AGROSTER (Besugárzó Rt.), and MEDICOR. The fifth row consists of several university logos: SZÉCHÉNYI EGYETEM, DEBRECENI EGYETEM, MISKOLCI EGYETEM (UNIVERSITY OF MISKOLC), DrJuice Co., mta ttk, and two other university logos.

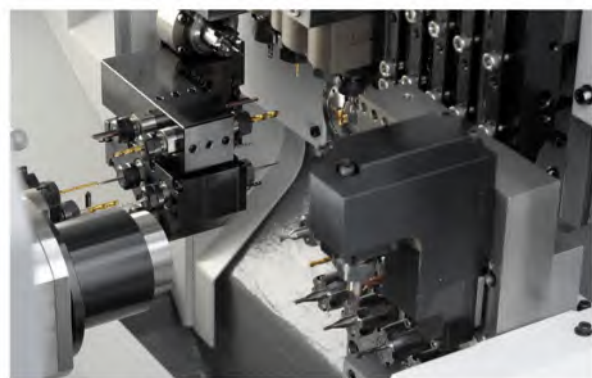

Quality management and guarantee

The quality of the products is guaranteed by design, manufacturing and quality management according to the harmonized European Union laws. The BIONIKA Medline Kft. is operated according to the EN ISO 9001 and the EN ISO 13485 quality management system. Our products are provided with CE marks, which was ensured by EMKI and QT-CERT.

We provide a long-term, 10-year guarantee for our products. After inserting the implant, reducing the medical risk of the ossification process, independently of cause and effect relationship – exchange guarantee is ensured within one year after the purchase for the dropped and fallen out implants.



BIONIKA Medline Kft. has always paid close attention to quality and reliability during its more than 30 years of existence. The Bisnode certificate is proof of our reliability and stability. BIONIKA also received a "Triple A" Bisnode qualification in 2016-2022.

With AAA (triple A) rating, only 0.63% of companies in Hungary have the financial risk of establishing a business relationship with them - source: dnb.hu

Superclean implant surface

BIONIKA demonstrates the best qualities of Grade 4 titanium used in implant manufacturing for dental implantology according to the ISO 5832-2 ASTM F67 standard.

Due to its adequate purity the biocompatibility is exceptionally good as well as it is provided with exceptional solidity. Initially, we and other implant manufacturers preferred the higher purity titanium but due to solidity reasons nowadays almost every implant is made of Grade 4 or other alloyed titanium in the world.

In all cases of implant abutments, alloyed, high strength Grade 5 titanium is applied according to the ISO 5832-4 ASTM F136 standard. The titanium applied according to the standard is provided with exceptional biocompatibility, it is almost risk-free. Almost all professionals see that the implantation success is best determined by the implantologist's practice, as well as surgical conditions, carefully maintained hygiene, and patient abilities.

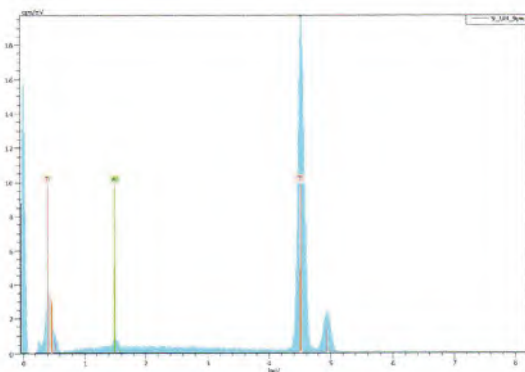

Energy dispersive X-ray spectrometric elemental analysis of Bionika implants*

* Source: FOGORVOSI SZEMLE, year 106. No. 4 2013. 135-143

The main steps of our BioTiS surface finish technology:

- Chemical, mechanical surface cleaning and surface dewing
- Special ultrasonic cleaning, surface cleaning and sterilization
- Transformation of surface structure by acidification process
- Multi-stage dehumidification, cleaning
- Electrochemical surface modification
- sterilization
- Surface finish in physiological solution

These technological steps are always carried out under sterile conditions.

The final packaging of the implants is four-layered. The packaging is carried out in a sterile cabin. Final sterility is assured by an accredited 20 Rad gamma sterilization procedure.

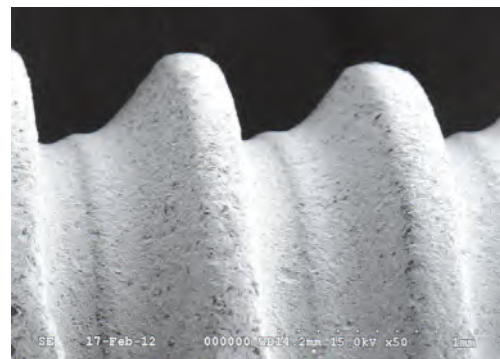

Bionika implant electron microscope image *



Bionika implant electron microscope image *

Applied raw materials



Titanium grade 4

Chemical composition

Elements	Threshold limit of constituents(%)
O	0,4 max.
Fe	0,3 max.
C	0,1 max.
N	0,05 max.
H	0,0125 max.
Ti	>99% / balance

Mechanical properties

solidity	680 MPa min.
dilation	10 %

According to the **ISO 5832-2** standard.

Titanium Grade 5

Chemical composition

Elements	Threshold limit of constituents(%)
Al	5,5-6,75 max.
V	3,5-4,5 max.
Fe	0,3 max.
O	0,2 max.
C	0,08 max.
N	0,05 max.
H	0,015 max.
Ti	balance

Mechanical properties

solidity	860 MPa min.
dilation	10 %

According to the **ISO 5832-3** standard.

CoCr

Chemical composition

Elements	Threshold limit of constituents(%)
C	0,1 max.
Si	1,0 max.
Mn	1,0 max.
P	0,005 max.
S	0,005 max.
Cr	30, 0 max.
Mo	7,0 max.
Ni	1,0 max.
Co	-
N	0,2250 max.

Mechanical properties

solidity	1240,00 MPa min.
elongation limit	900,00 min.
elongation at break	18,00 min.
fracture contraction	23,00 min.

According to the **ISO 5832-4** standard.

Plastics

POM (polyoxymethylene) : Thermoplastic synthetic plastic, Excellent properties eg: high hardness, low wear, good flexibility, little absorbing ability. Density: 1.41 g / cm³. elongation at break: min. 30% Current Voltage: min. 65 Mpa. Its color is white.

PEEK (polyether ether ketone) :High heat-resistant plastic, suitable for all conventional sterilization methods (steam, dry heat, ethylene oxide, gamma radiation). Density: 1.30 1.41 g / cm³ Tensile strength: 115 Mpa. elongation at break: min. 17% Its colour is natural brownish gray.

SCANDREA packaging



10 - piece collection box



vial in sterile foil



removing the foil



sterile vial



removing the locking plug
(1)



removing the locking plug
(2)



using the implant key driver



removing the implant



Collection box

Depending on the order quantities, collection boxes with 5 and 10 pieces are applied.

SCANDREA packaging

According to our endeavor, the raw materials used in packaging are almost 100% naturally occurring, environmentally-friendly, natural materials.

aluminum · titanium · glass · caoutchouc · paper

Vial

The first layer of the packaging is a transparent vial, which ensures the total, null colony-forming unit sterility. The locking plug of the vial holds the implant, the multifunctional implant head and the locking screw.

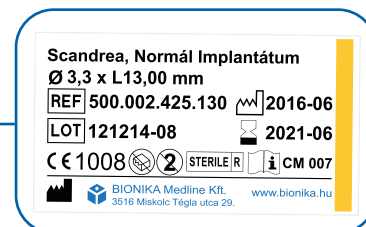

Paper box

The outer layer of the packaging is a paper box with a high density, which is for the physical safety. Every paper box is provided with colour-coded labels according to the different platform- diameters. The colour of the packaging is adjusted to this method.







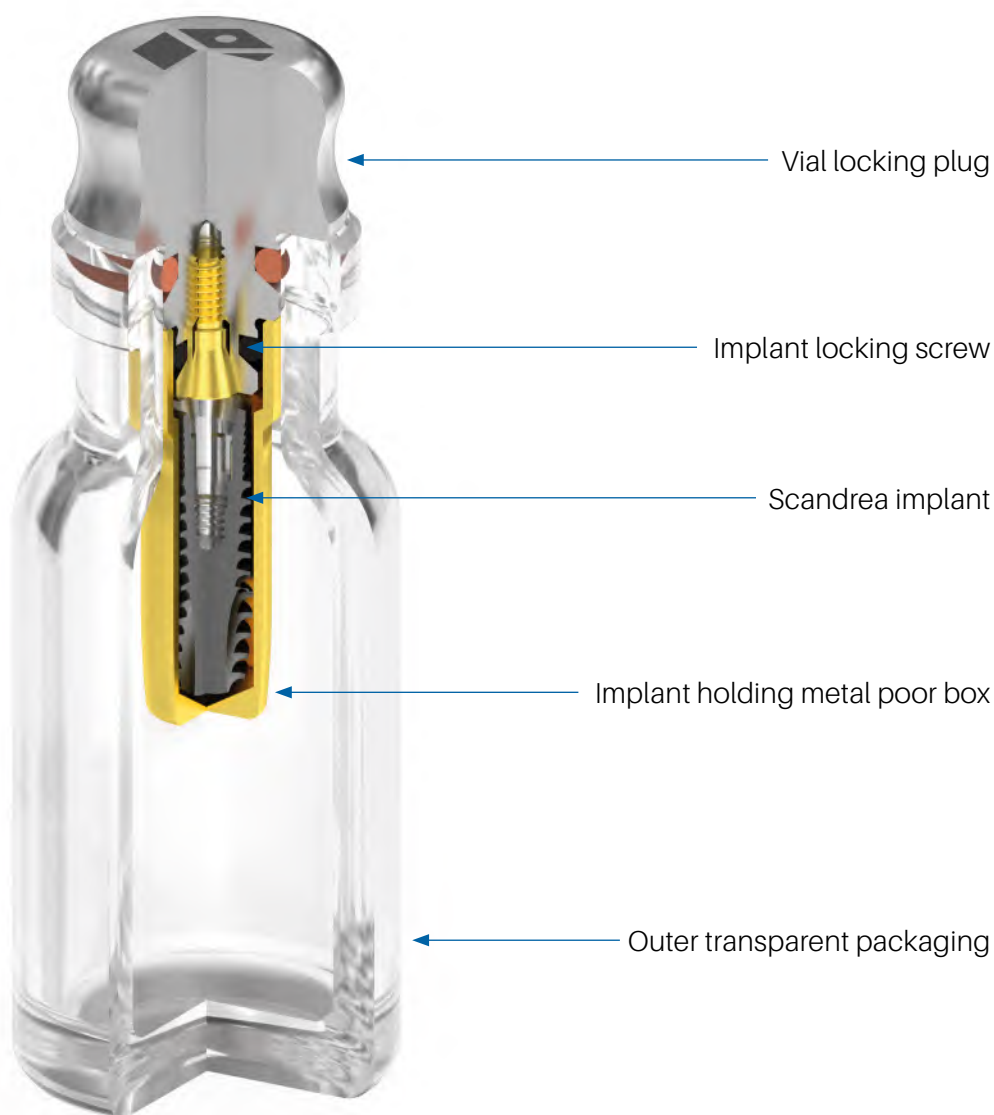

The sectional image of the packaging and its accessories

The inner layer of the packaging is the poor box which holds the implant. The implant itself can be found in the poor box. The locking plug of the vial holds the poor box, with this it can be removed from the vial. The implant locking screw can be found in the plug as well.



SCANDREA product labels and their notation

Differential platform diameters by colour and diameter (mm):

-  2,8 - turquoise
-  3,0 - grey
-  3,8 - yellow
-  4,3 - purple
-  5,0 - blue
-  6,0 - green
-  7,0 - white

Information supplied by the three product labels on the outer packaging of the Implant System:

The side of the box:

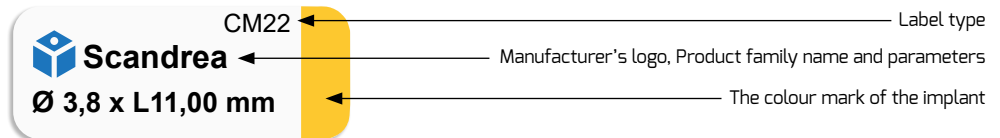



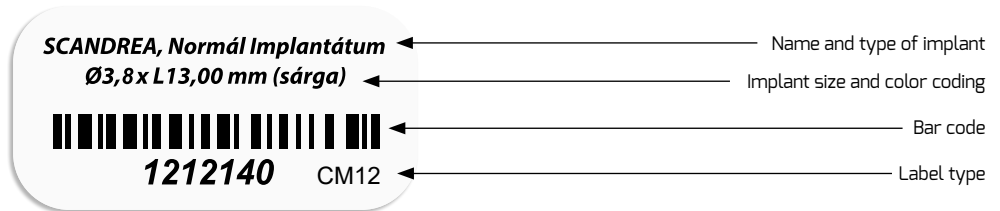



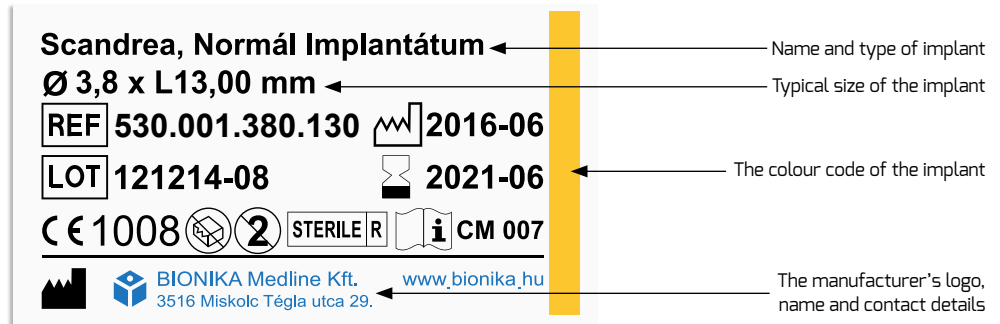







Top of the box:



The back of the box:



Explanation of label codes:

<p> Diameter</p> <p> Implant length</p> <p> Item number</p> <p> Serial number</p> <p> Production time</p>	<p> Expiration date</p> <p> It is forbidden to use in the case of damaged packaging.</p> <p> Reuse is forbidden!</p> <p> Sterilized with gamma rays</p> <p> sterilized with steam or dry heat</p>	<p> Non-sterile product in the package</p> <p> Read the usage guide!</p> <p> Certification company code</p> <p> Manufacturer's name and Contact</p>
--	--	---

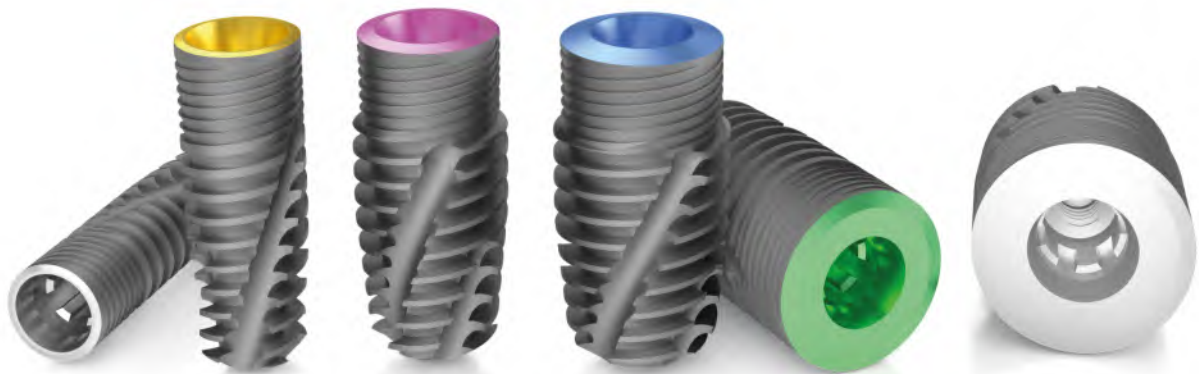

The products in the publication are only illustrations, they do not cover the exact appearance and shape of the product.



SCANDREA

IMPLANT SYSTEM

IMPLANTS



SCANDREA IMPLANT SYSTEM

The Scandrea Implant System is one of the lately developed implant system, which is the result of the as excellent engineering work as possible. The premium category Scandrea of BIONIKA system meets the highest expectations.

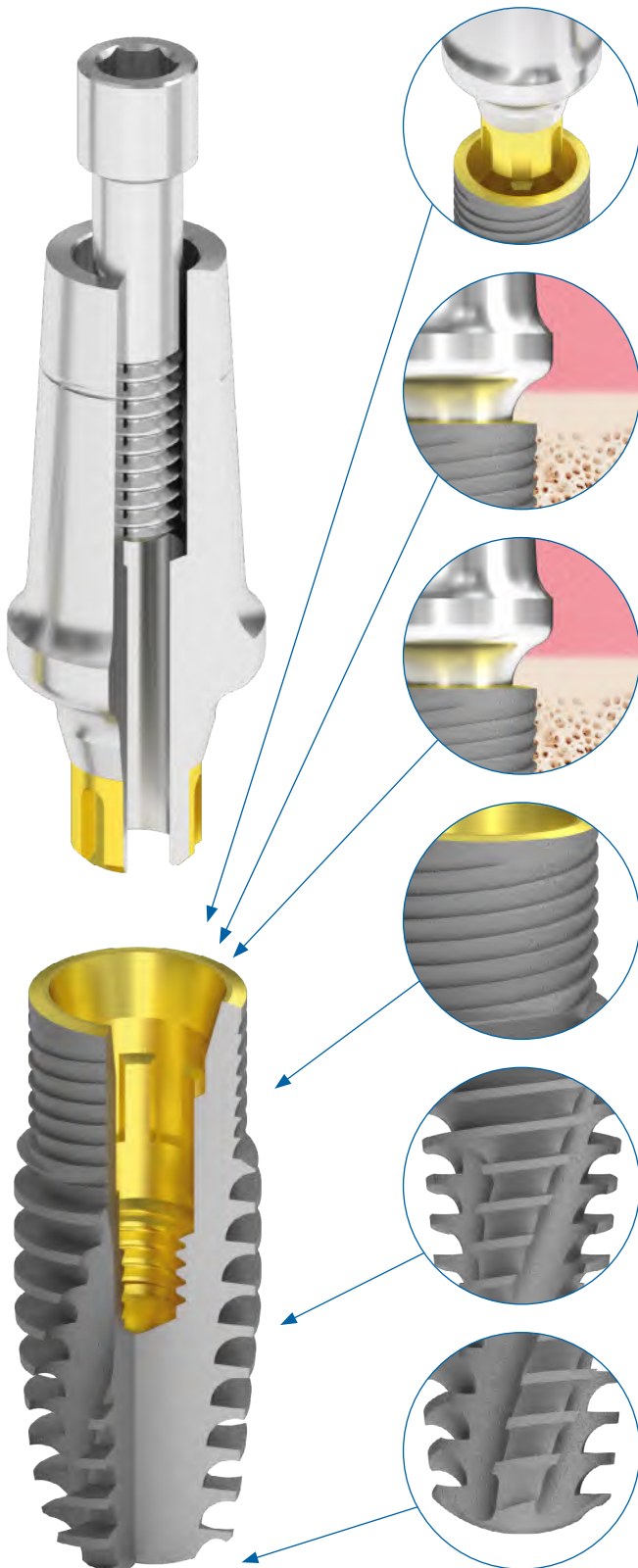

Connection: Conical-Connection

A fixation is used which eventuates micromotor-free power transmission and offers favorable conditions for the accurate sampling. It superimposes the powers deep right into the implant.

Cortical Level

The chances of the implant persistency are significantly improved by inserting the upper edge of the implant at the cortical level or below.

Platform switching

The diameter of the abutment is smaller than the outer part of the implant which is connected to the bone. The bone can move to the upper edge of the implant.

Spirally microstriated surface

The microstriated spiral surface can function as a significant weight bearing element. The self-closing thread structure and the cycloid cord thread ensure a micromotor-free condition and fast inserting.

Anatomical tooth root form

Due to the conicity, high thread pitch, high thread deepness, self-closing and self-tapping shaping of the implant screw thread, it has a bone-compacting effect and with due diligence it can be immediately loaded.

Rounded implant end

It helps facilitating the minor direction changes when inserting the implant.

The functional structure of the Scandrea Implant System elements

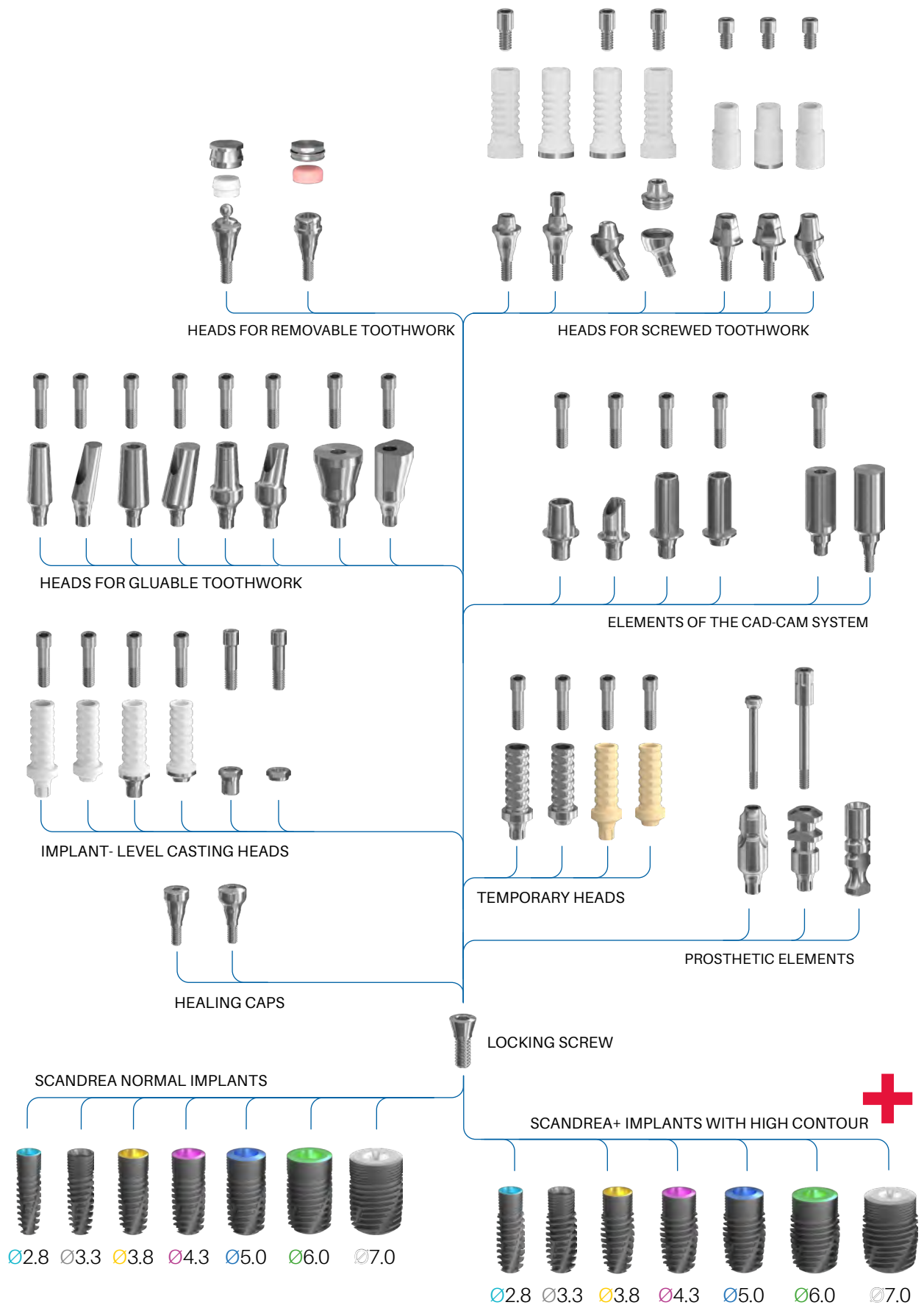

The applicational fields of the **Scandrea** Implant System



In the case of one tooth deficit

In this case of the replacement of a tooth, we do not have to grind two healthy teeth for bridge replacement, but inserting an implant, then we need to glue a crown in the same way as the traditional one.

In the case of end of line tooth deficit(s)

In this case, in the absence of a pillar tooth, we are not able to make a fixed replacement (bridge). With the implantation of at least two implants, you are already make the (fixed) bridge replacement.



Removable denture

In the case of total tooth deficit

In this case the patient has no tooth, complete tooth augmentation can be performed. In this case, there one solution is the removable denture: 2-4 implants are implanted, these will be the fixation for the removable tooth.

This brings a tremendous quality of life to the patient, as this way the denture will be very stable, so it can be used in chewing and speaking outright.

There are two solutions possible in this case: ball head or locator head abutments can be applied. With the implantation of several 6-8 implants, it is possible to make full fixation (round bridge) augmentation, which is both functional and aesthetically close to the natural teeth.

Screw-retained fixed dental prosthetics with 4 or 6 implants

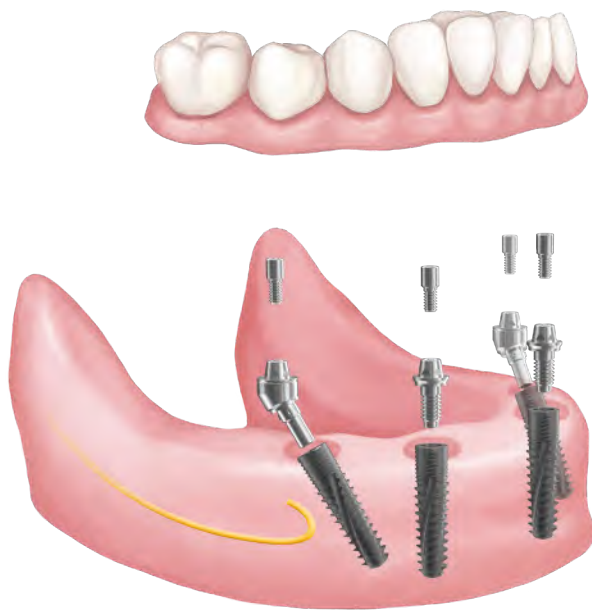

Optimum Concept

Optimum Concept

All-on-4® type - Economical Solution

The **Optimum Concept** provides great stability, with only four implants being implanted.

- The temporary denture can be inserted on the day of surgery.
- Immediate improvement in function, speech and aesthetically.
- Treatment times are shorter and costs can be lower than conventional implant placement modes.
- Tilt rear implants can be fixed better into the front bone. This promotes prosthesis support.

Safe Concept

All-on-6® type - For extra stability

The stability of the toothwork can be increased with the **Safe Concept**. It is exceptionally advantageous in the case of extra chewing ability.

- The usage of oblique head implants allows longer implants to be used, avoiding the nerve canal.
- The usage of longer implants allows the bone and the implant to touch on a larger surface, thus making bone augmentation avoidable.
- Favorable bone level for tilted and axial implants.
- High remaining chances.

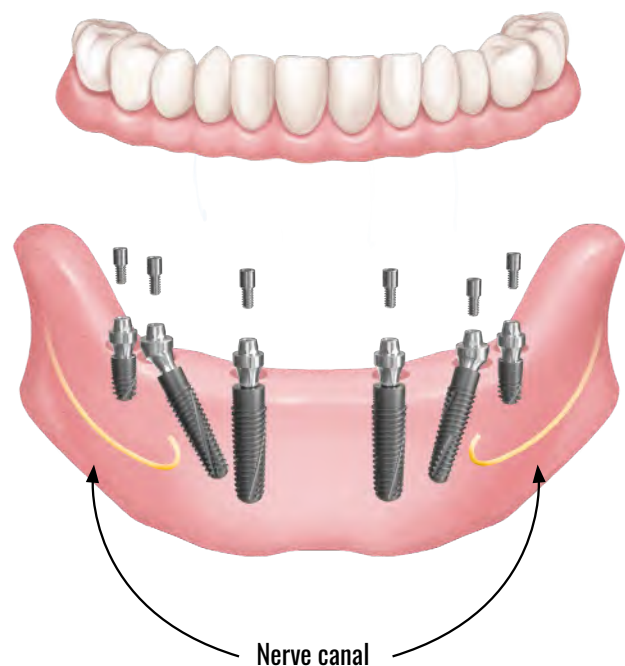

Safe Concept

SCANDREA Implants with Ø2.8 platform

The thin Scandrea implants with Ø2.8 mm and Ø3,3 mm diameter and Ø2.8 mm platform is exceptionally suitable in the case of thinner than average bone structures for keeping the toothworks on the long run. The raw material of it is homogeneous titanium alloy with a high density.

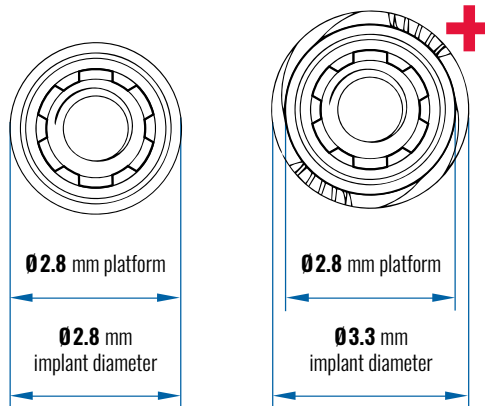

NORMAL IMPLANT

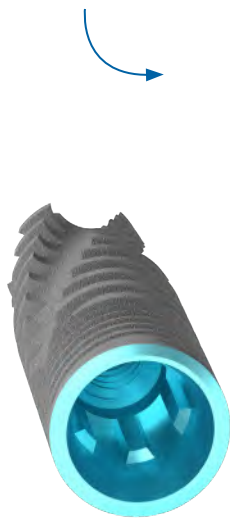

IMPLANT WITH HIGH CONTOUR

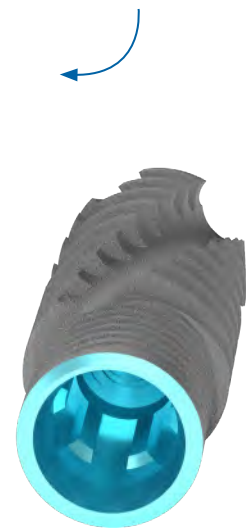

SCANDREA MANUAL IMPLANT KEY DRIVER



Ø 2.8 mm
L 6 mm



Ø 2.8 mm
L 12 mm



Ø 2.8 mm
L 6 mm



Ø 2.8 mm
L 12 mm



SCANDREA MECHANICAL IMPLANT KEY DRIVER

Sizes available of the implant with Ø2.8 mm platform

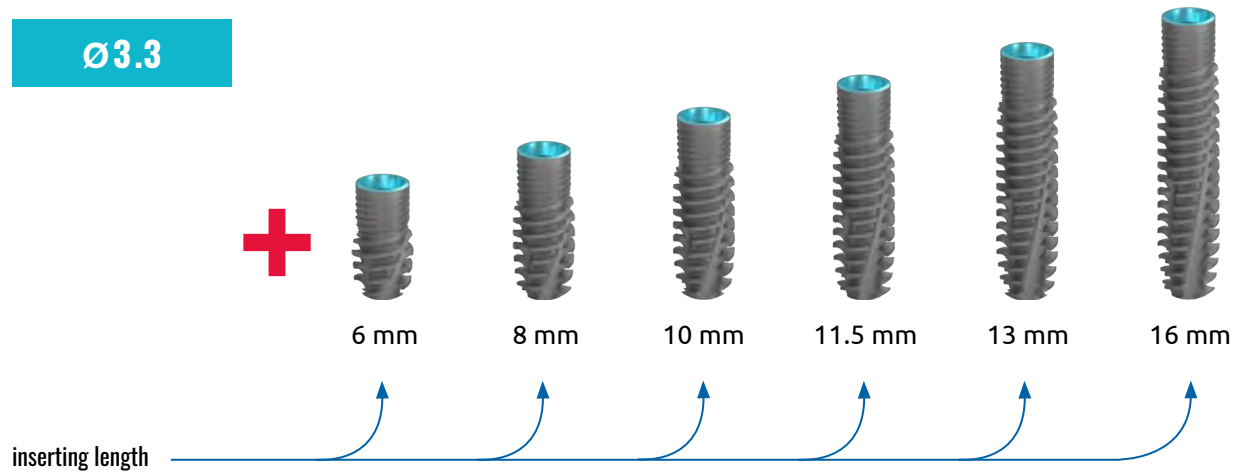
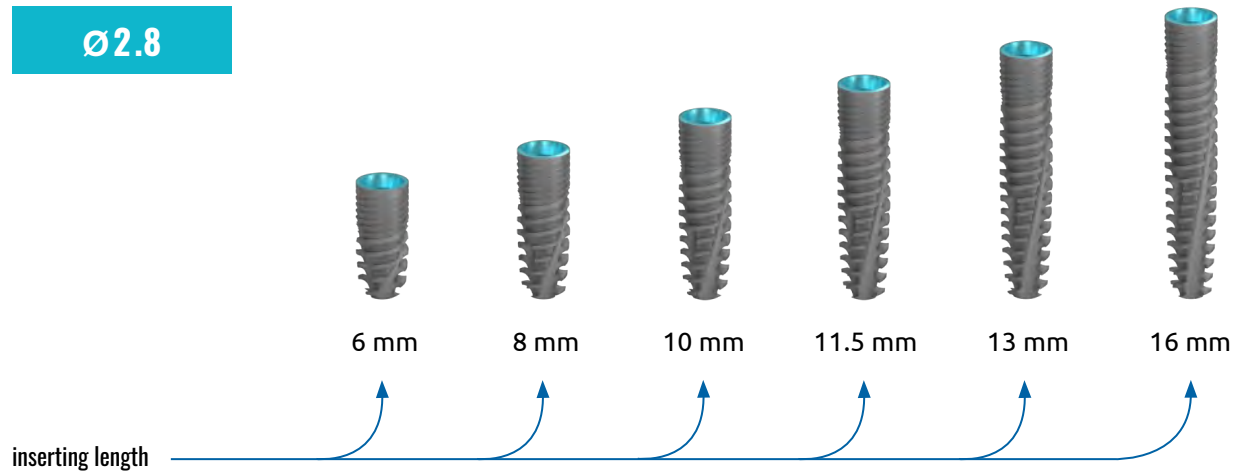

The drilling protocol of the Scandrea implant with Ø2.8 mm platform

Drilling indicators:

- - alternatively used
- ◐ - ½ length drilling alternatively
- - recommended drilling in ¾ or in full length

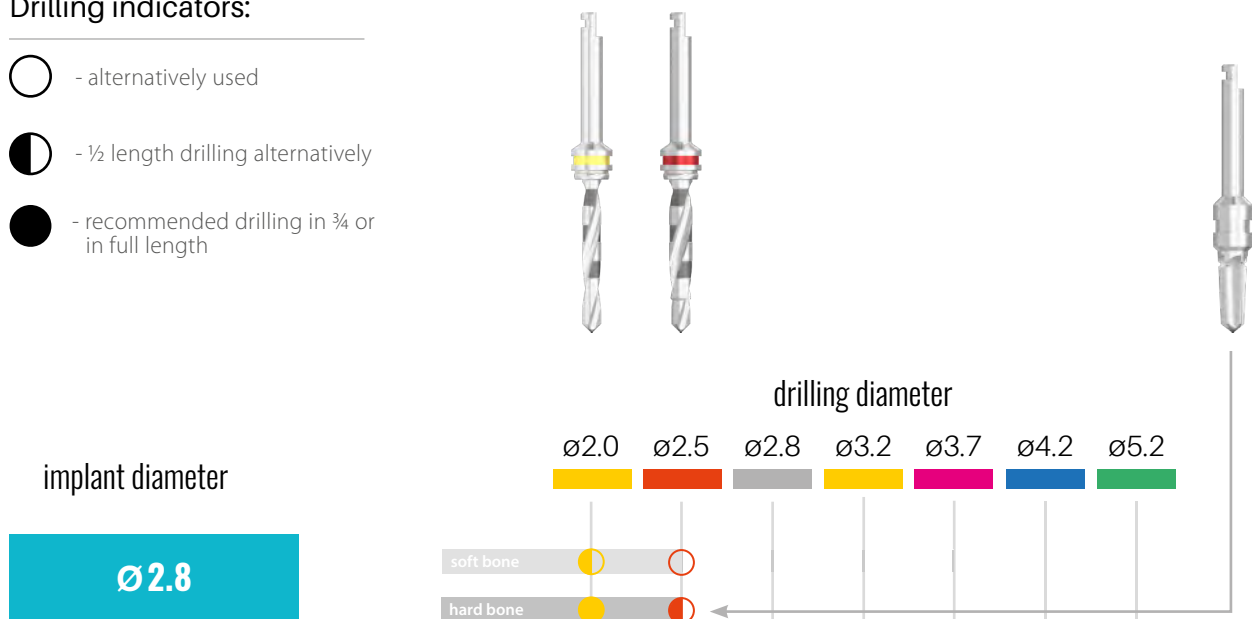

Ø2.8

SCANDREA Implants with Ø3.3 platform

The thin Scandrea implants with Ø3.3 mm and Ø3.8 mm diameter and Ø3.3 mm platform is exceptionally suitable in the case of thinner than average bone structures for keeping the toothworks on the long run. The raw material of it is homogeneous titanium alloy with a high density.

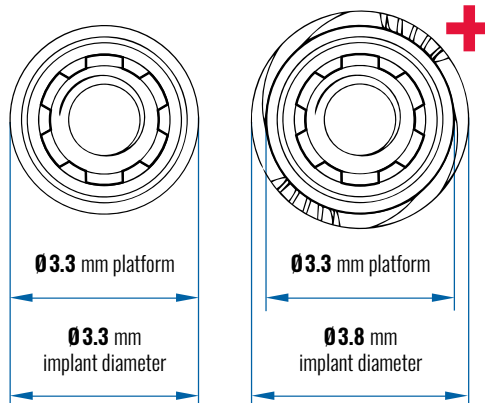

NORMAL IMPLANT

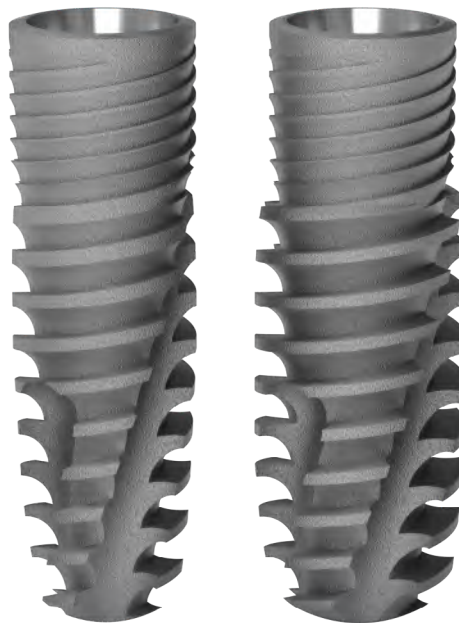

IMPLANT WITH HIGH CONTOUR



SCANDREA MANUAL IMPLANT KEY DRIVER



Ø 3.3 mm
L 6 mm



Ø 3.3 mm
L 12 mm



Ø 3.3 mm
L 6 mm



Ø 3.3 mm
L 12 mm



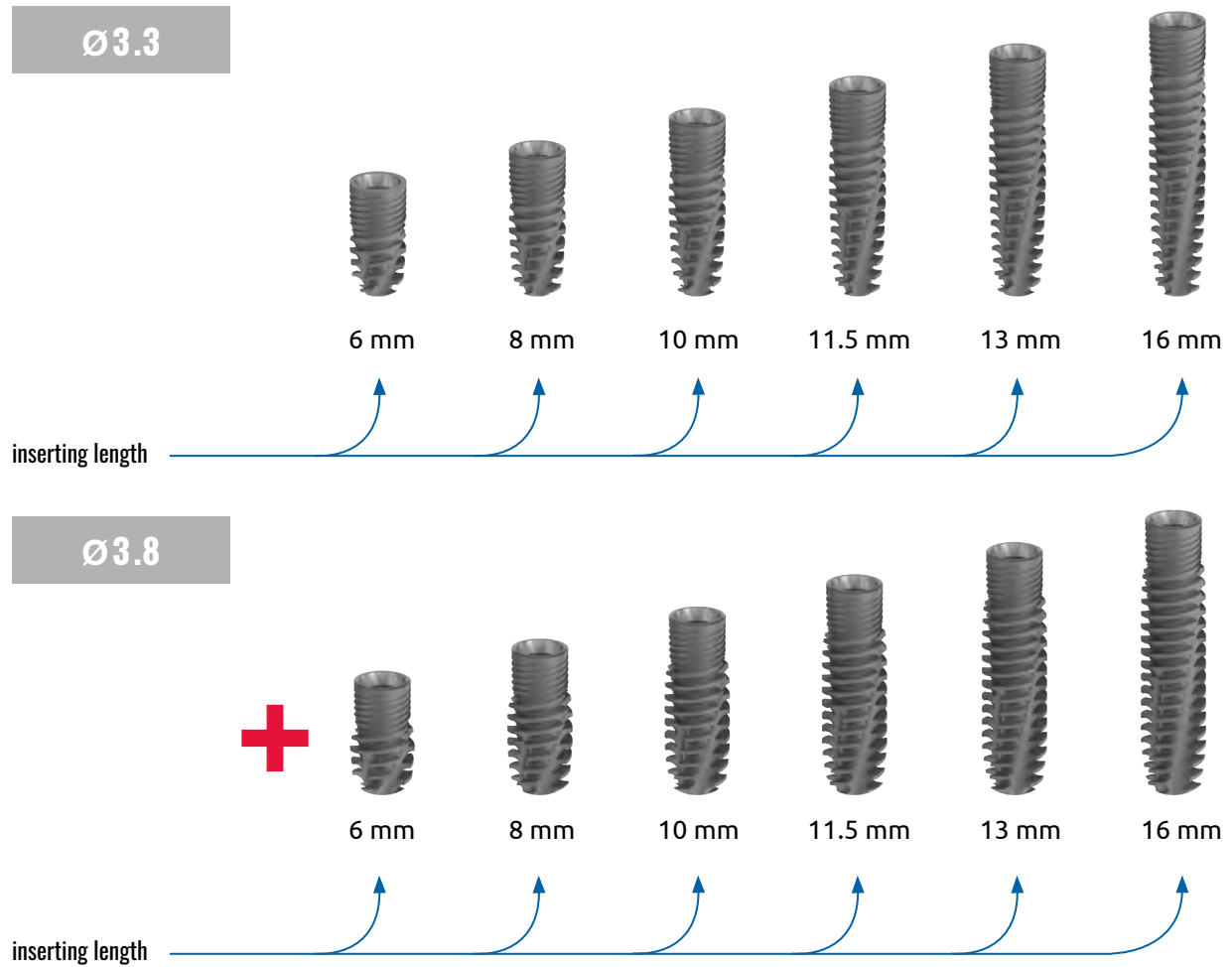

Sizes available of the implant with Ø3.3 mm platform



The drilling protocol of the Scandrea implant with Ø3.3 mm platform

Drilling indicators:

-  - alternatively used
-  - ½ length drilling alternatively
-  - recommended drilling in ¾ or in full length

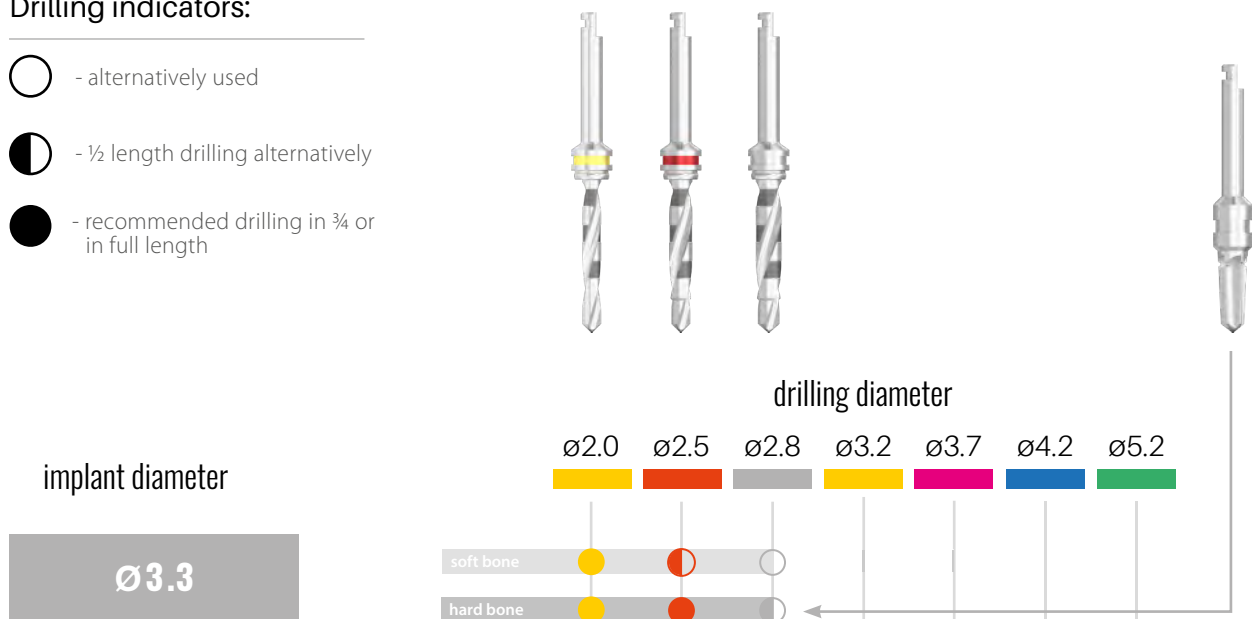

SCANDREA Implants with Ø3.8 platform

The normal Scandrea implants with Ø3.8 mm and Ø4.3 mm diameter and Ø3.8 mm platform is exceptionally suitable in the case of average bone structures for keeping the toothworks on the long run. The 75 % of the occurring cases can be covered with this type.

The raw material of it is homogeneous titanium alloy with a high density.

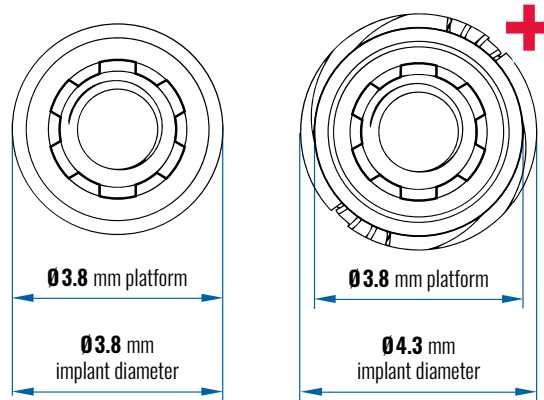

NORMAL IMPLANT

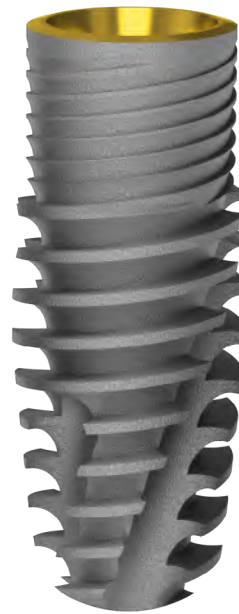
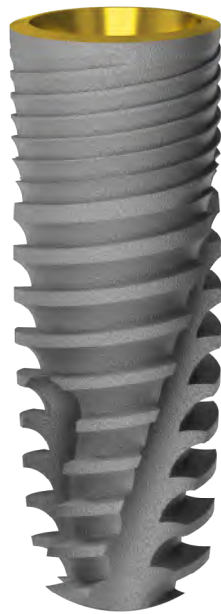

IMPLANT WITH HIGH CONTOUR



SCANDREA MANUAL IMPLANT KEY DRIVER



Ø 3.8 mm
L 6 mm



Ø 3.8 mm
L 12 mm



Ø 3.8 mm
L 6 mm



Ø 3.8 mm
L 12 mm



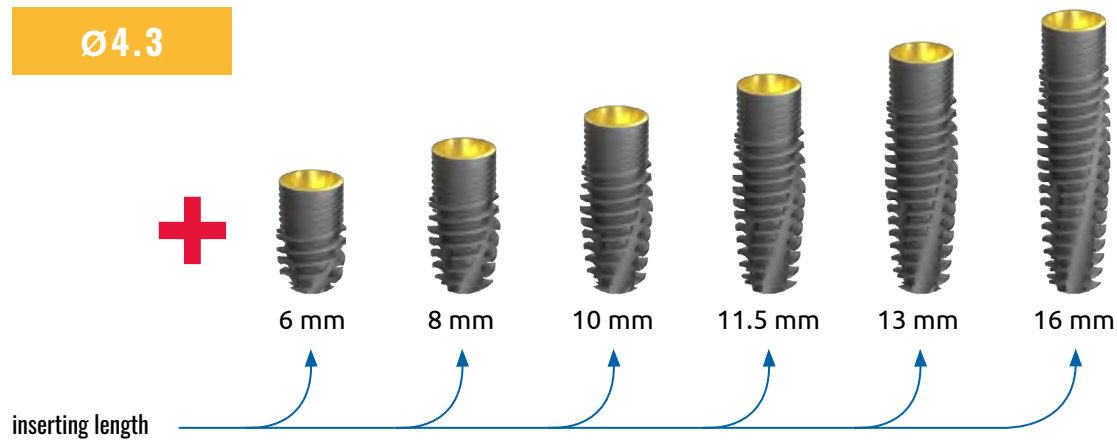
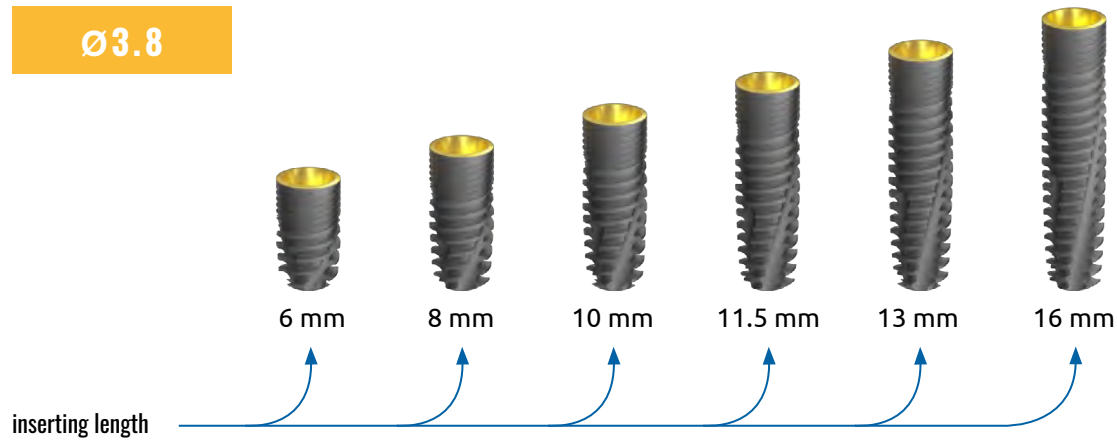

SCANDREA MECHANICAL IMPLANT KEY DRIVER

Sizes available of the implant with Ø3.8 mm platform



The drilling protocol of the Scandrea implant with Ø3.8 mm platform

Drilling indicators:

-  - alternatively used
-  - ½ length drilling alternatively
-  - recommended drilling in ¾ or in full length

implant diameter

Ø3.8

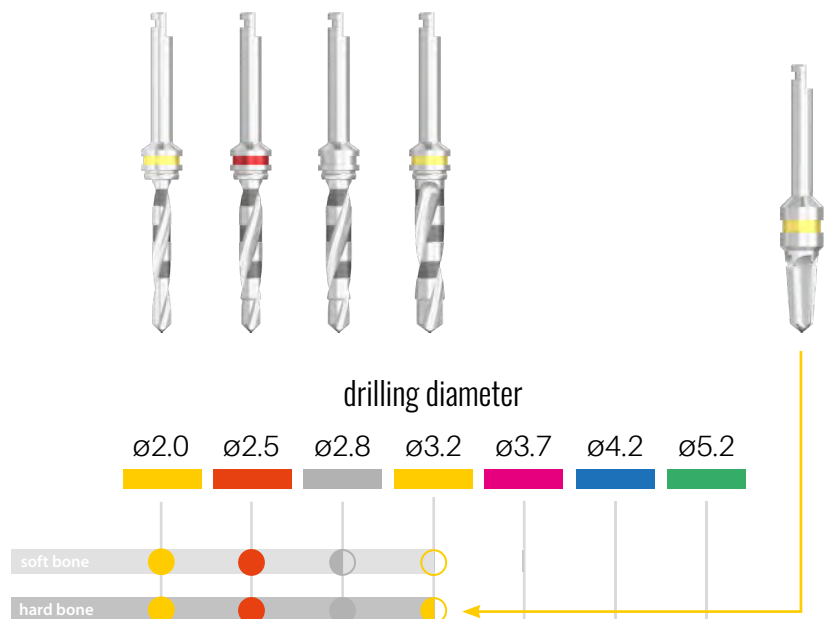

SCANDREA Implants with Ø4.3 platform

The normal Scandrea implants with Ø4.3 mm and Ø4.8 mm diameter and Ø4.3 mm platform is exceptionally suitable in the case of average bone structures for keeping the toothworks on the long run. The 75 % of the occurring cases can be covered with this type.

The raw material of it is homogeneous titanium alloy with a high density.

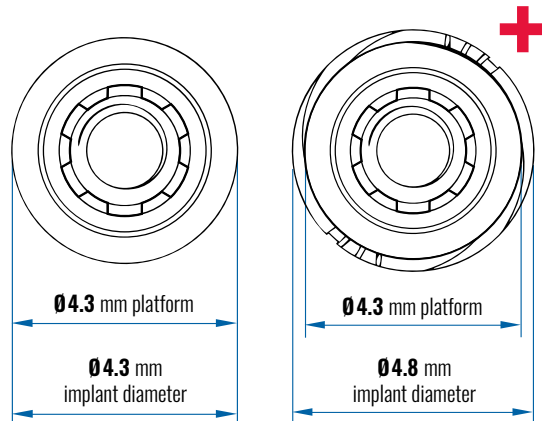

NORMAL IMPLANT

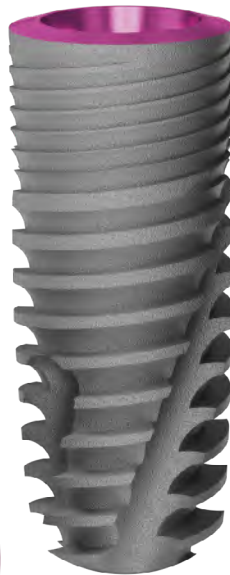

IMPLANT WITH HIGH CONTOUR



SCANDREA MANUAL IMPLANT KEY DRIVER



Ø 3.8 mm
L 6 mm



Ø 3.8 mm
L 12 mm



Ø 3.8 mm
L 6 mm



Ø 3.8 mm
L 12 mm



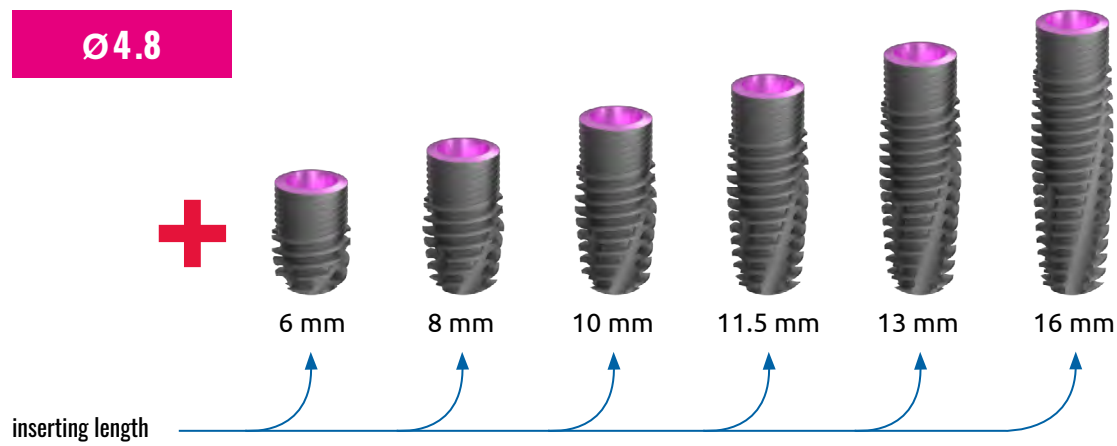
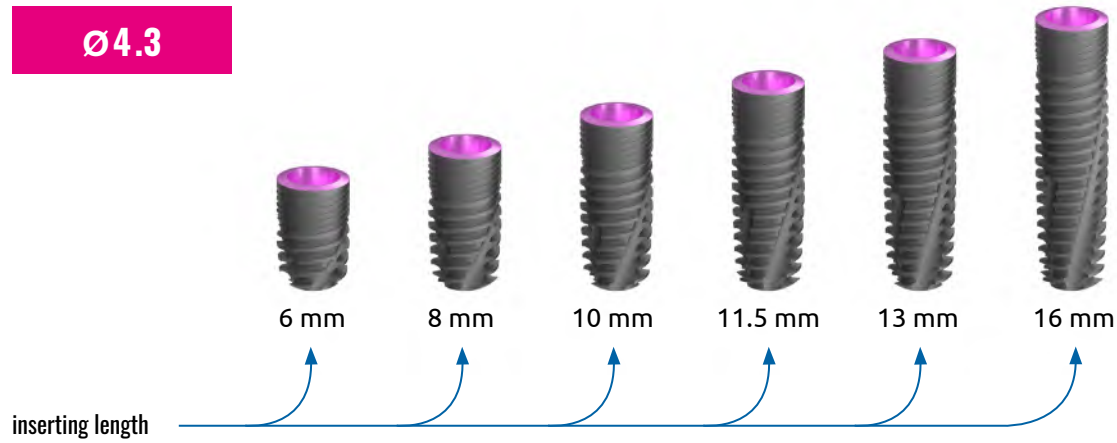

Sizes available of the implant with Ø4.3 mm platform



The drilling protocol of the Scandrea implant with Ø4.3 mm platform

Drilling indicators:

-  - alternatively used
-  - ½ length drilling alternatively
-  - recommended drilling in ¾ or in full length

implant diameter

Ø4.3

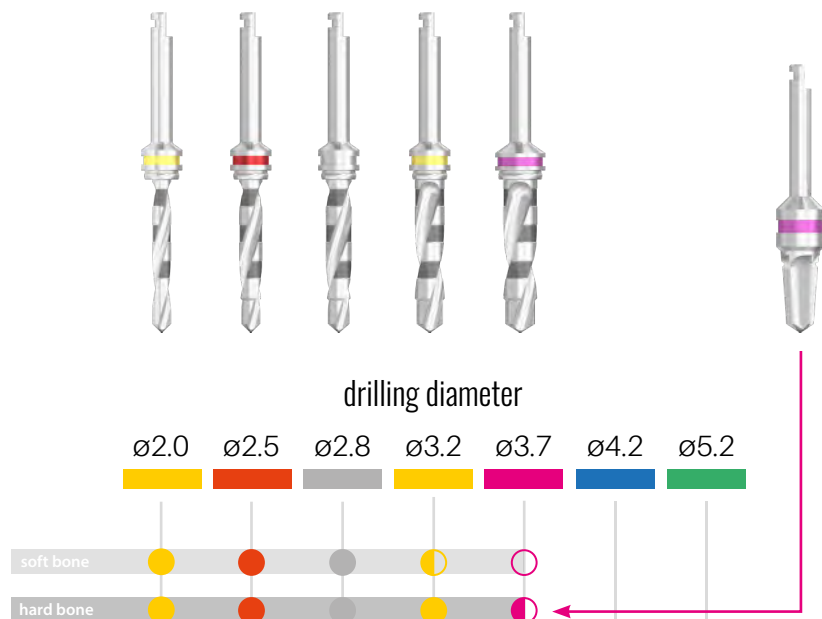

SCANDREA Implants with Ø5.0 platform

The thick Scandrea implants with Ø5.0 mm and Ø5.5 mm diameter and Ø4.3 mm platform is exceptionally suitable in the case of bigger than average bone structures for keeping the toothworks on the long run.

The raw material of it is homogeneous titanium alloy with a high density.

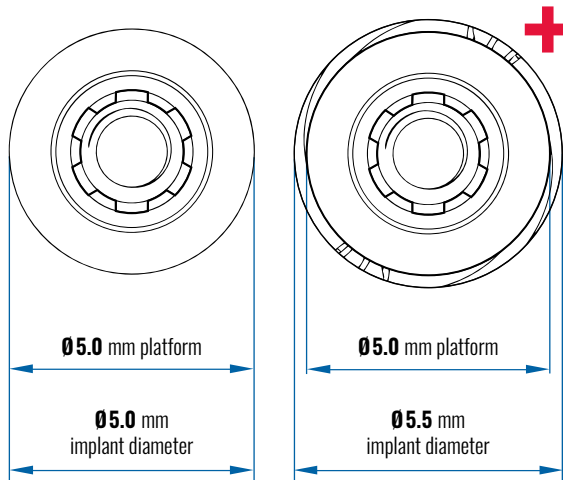

NORMAL IMPLANT

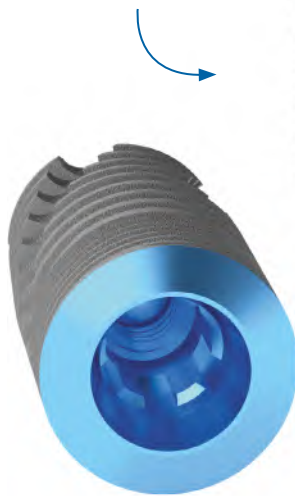

IMPLANT WITH HIGH CONTOUR



SCANDREA MANUAL IMPLANT KEY DRIVER



Ø 3.8 mm
L 6 mm



Ø 3.8 mm
L 12 mm



Ø 3.8 mm
L 6 mm



Ø 3.8 mm
L 12 mm



SCANDREA MECHANICAL IMPLANT KEY DRIVER



Ø 3.8 mm
L 6 mm



Ø 3.8 mm
L 12 mm



Sizes available of the implant with Ø5.0 mm platform

Ø5.0

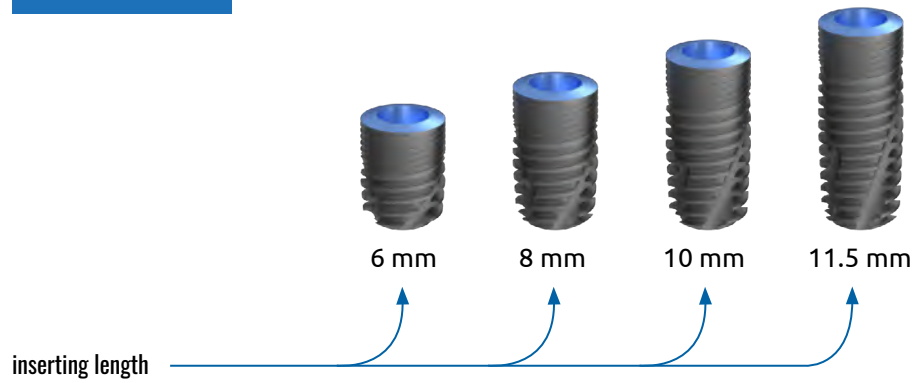

Ø5.5

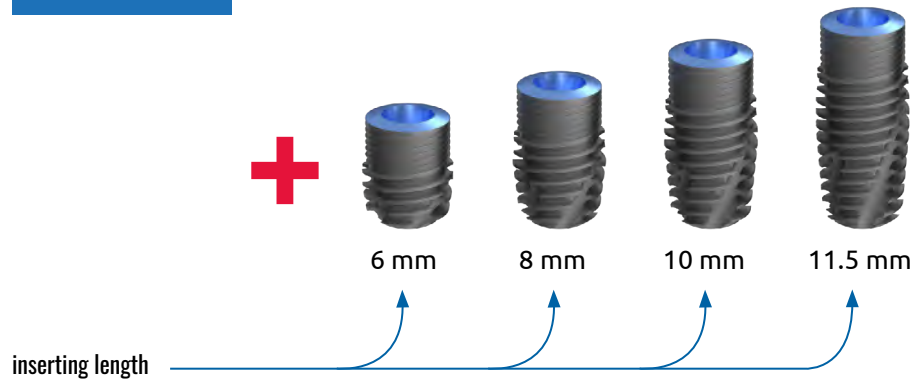

The drilling protocol of the Scandrea implant with Ø5.0 mm platform

Drilling indicators:

- - alternatively used
- ◐ - ½ length drilling alternatively
- - recommended drilling in ¾ or in full length

implant diameter

Ø5.0

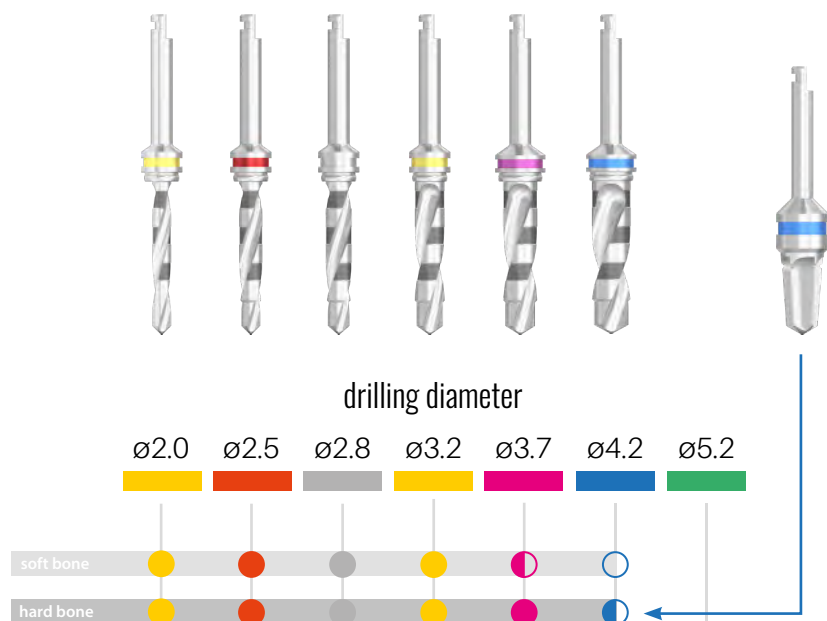

SCANDREA Implants with Ø6.0 platform

The thick Scandrea implants with Ø6.0 mm and Ø6.5 mm diameter and Ø6.0 mm platform is exceptionally suitable in the case of bigger than average bone structures for keeping the toothworks on the long run.

The raw material of it is homogeneous titanium alloy with a high density.

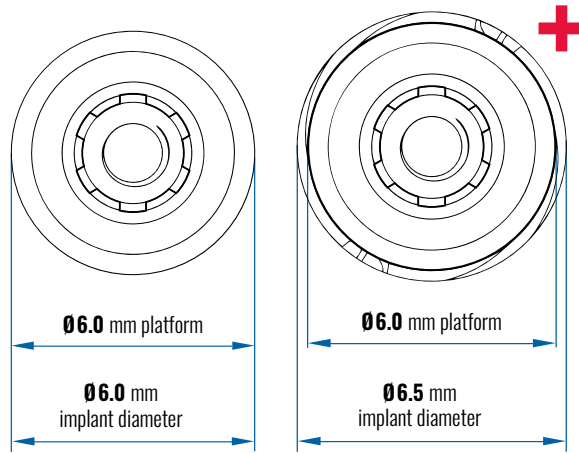

NORMAL IMPLANT

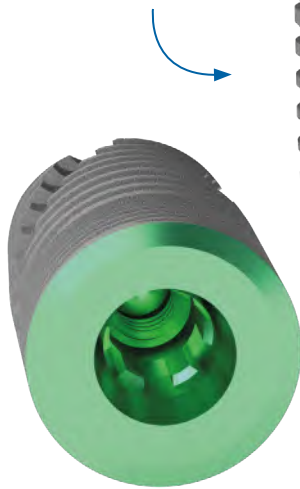

IMPLANT WITH HIGH CONTOUR



SCANDREA MANUAL IMPLANT KEY DRIVER



Ø 6.0 mm
L 6 mm



Ø 6.0 mm
L 12 mm



Ø 6.0mm
L 6 mm



Ø 6.0 mm
L 12 mm



SCANDREA MECHANICAL IMPLANT KEY DRIVER



Ø 6.0mm
L 6 mm



Ø 6.0 mm
L 12 mm



Sizes available of the implant with Ø6.0 mm platform

Ø6.0

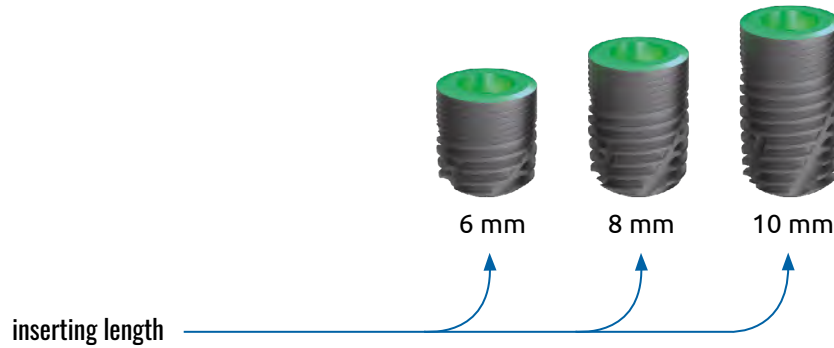

Ø6.5

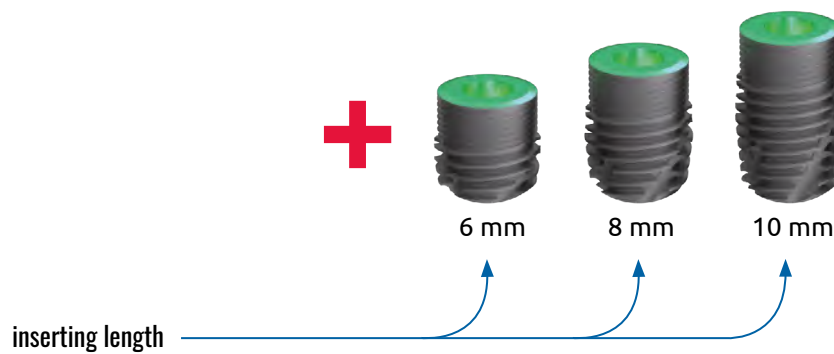

The drilling protocol of the Scandrea implant with Ø6.0 mm platform

Drilling indicators:

- - alternatively used
- ◐ - ½ length drilling alternatively
- - recommended drilling in ¾ or in full length

implant diameter

Ø6.0

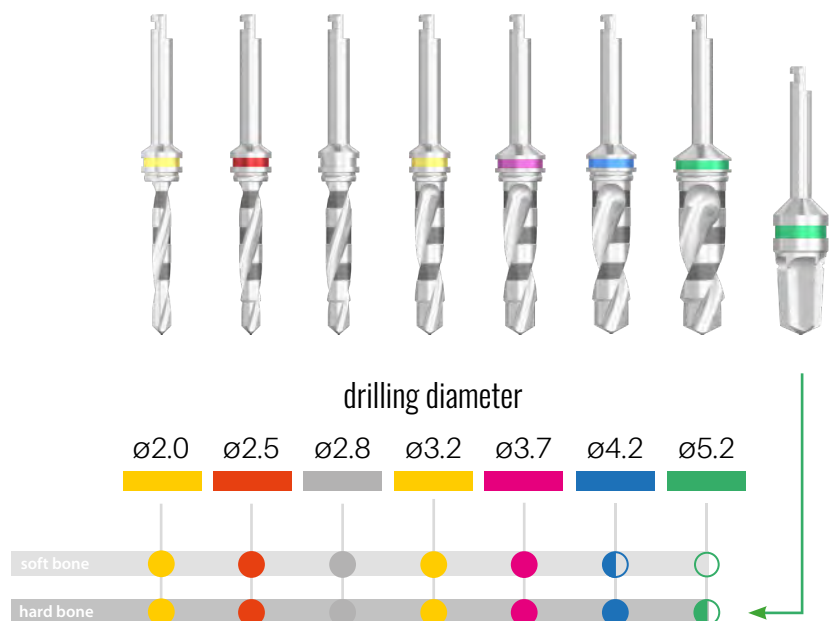

SCANDREA Implants with Ø7.0 platform

The normal Scandrea implants with Ø7.0 mm and Ø7.5 mm diameter and Ø4.3 mm platform is exceptionally suitable in the case of bigger than average bone structures for keeping the toothworks on the long run.

The raw material of it is homogeneous titanium alloy with a high density.

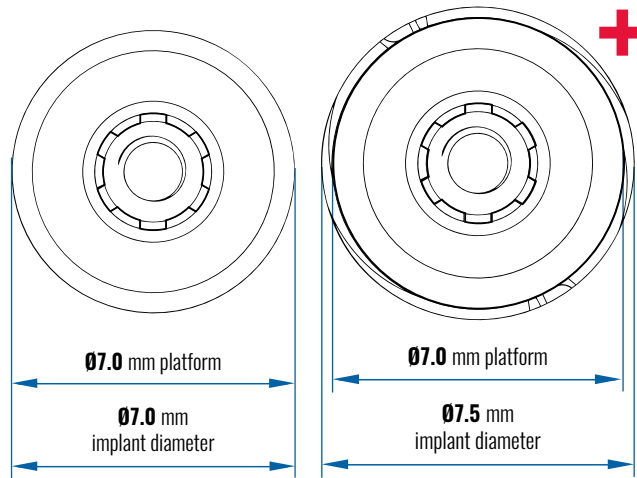

NORMAL IMPLANT



IMPLANT WITH HIGH CONTOUR



SCANDREA MANUAL IMPLANT KEY DRIVER



Ø 6.0 mm
L 6 mm



Ø 6.0 mm
L 12 mm



SCANDREA MECHANICAL IMPLANT KEY DRIVER



Ø 6.0mm
L 6 mm



Ø 6.0 mm
L 12 mm



Sizes available of the implant with Ø7.0 mm platform

Ø7.0

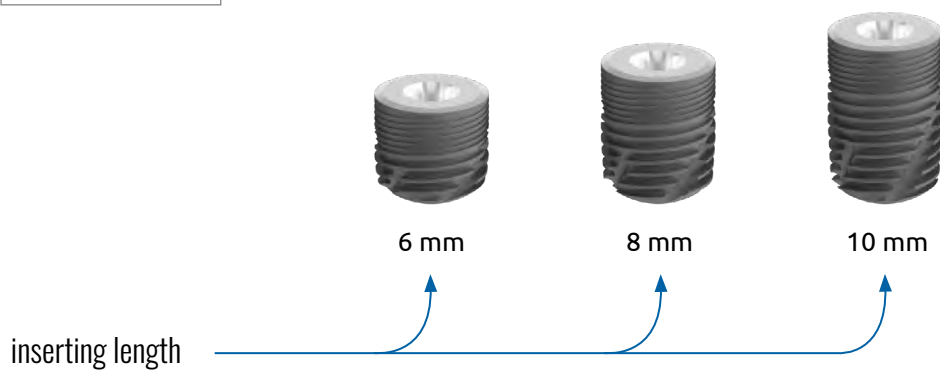

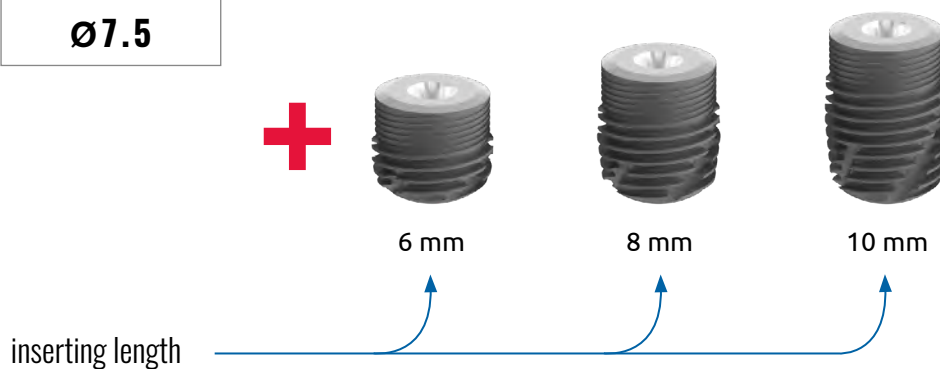

Ø7.5



The drilling protocol of the Scandrea implant with Ø7.0 mm platform

Drilling indicators:

-  - alternatively used
-  - ½ length drilling alternatively
-  - recommended drilling in ¾ or in full length



implant diameter

Ø7.0

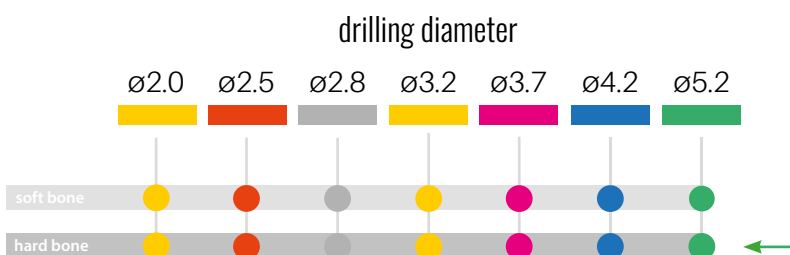



The products in the publication are only illustrations, they do not cover the exact appearance and shape of the product.



SCANDREA

IMPLANT SYSTEM

ABUTMENTS

SCANDREA Abutments

1. Implants

PROSTHETIC ELEMENTS

2. Technical implant
3. Healing cap, narrow
4. Healing cap, anatomical
5. Sampling head for closed spoon
6. Sampling head for open spoon
7. Temporary head, through-bolted, positioned
8. Temporary head, through-bolted, non-positioned
9. Temporary head, through-bolted, positioned, PEEK
10. Temporary head, through-bolted, non-positioned, PEEK

FOR GLUABLE TOOTHWORK

11. Narrow head, straight
12. Narrow head oblique
13. Universal head, straight
14. Universal head, oblique
15. Anatomical head, straight
16. Anatomical head, oblique
17. Trapezoidal head
18. Delta head

IMPLANT-LEVEL CASTING HEADS

19. Castable plastic head, positioned
20. Castable plastic head, non-positioned

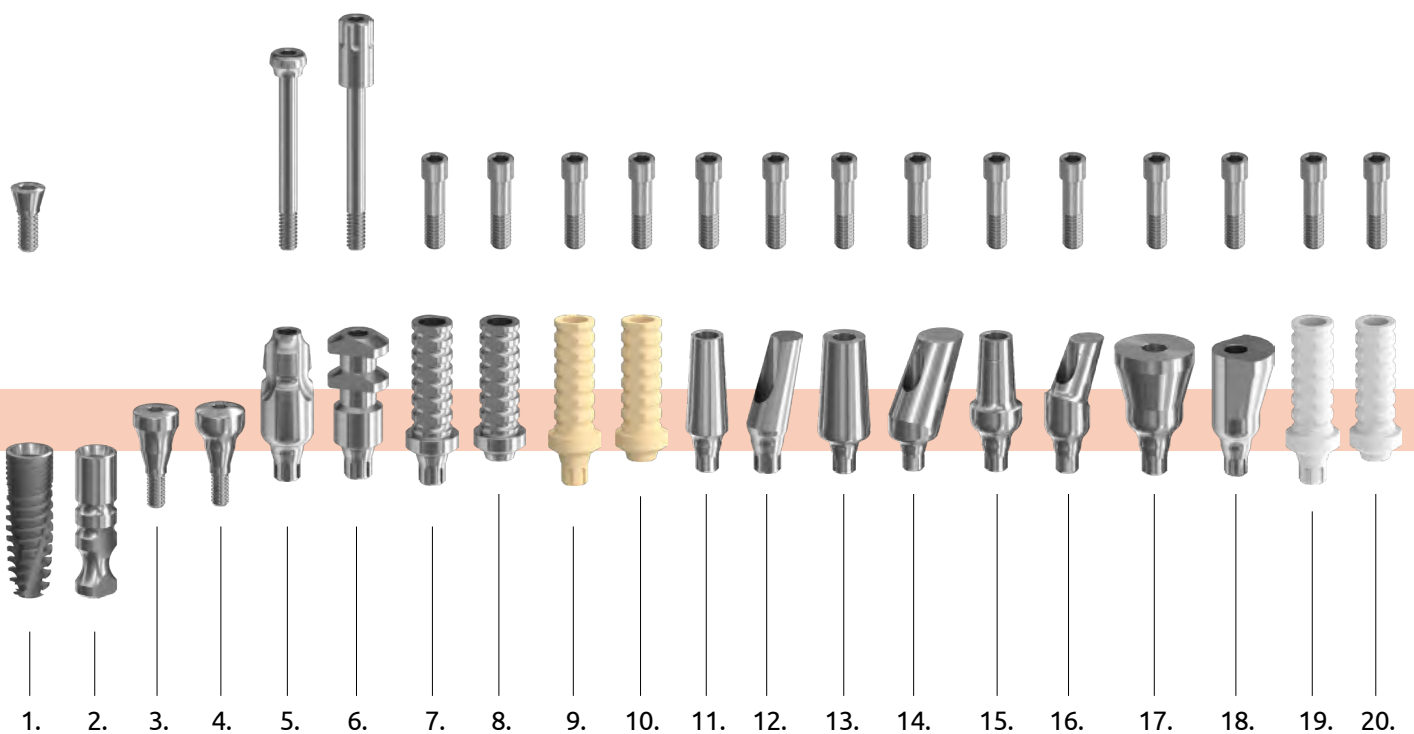

- 21. Cobalt chromium-based casting head, positioned
- 22. Cobalt chromium-based casting head, non-positioned
- 23. Interface, positioned
- 24. Interface, non-positioned

FOR REMOVABLE TOOTHWORK

- 25. Ball-head
- 26. Locator head, straight

FOR SCREWED TOOTHWORK

- 27. Multi-unit head, straight
- 28. Multi-unit head, through-bolted
- 29. Multi-unit head, oblique
- 30. MC head, oblique

- 31. Multi-unit SR head, screwable
- 32. Multi-unit SR head, through-bolted
- 33. Multi-unit SR head, oblique

ELEMENTS OF CAD-CAM SYSTEM

- 34. Titanium base
- 35. Press ceramic base
- 36. Tube-head, positioned
- 37. Tube-head, non-positioned
- 38. Scanbody head, through-bolted
- 39. Scanbody head, screwable

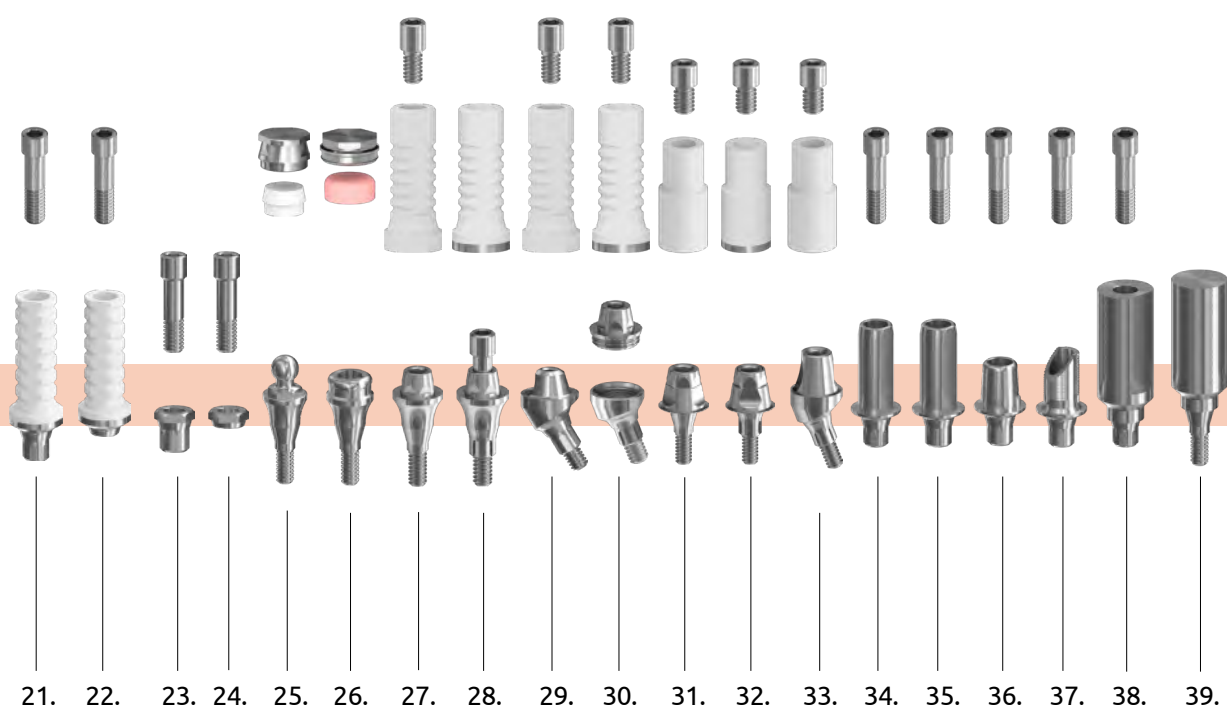

Sizes available of the Scandrea abutments

TECHNICAL IMPLANT

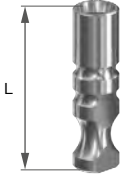

platform (mm)



 ø2,8 ø3,3 ø3,8 ø4,3 ø5,0 ø6,0 ø7,0

head height (L mm)

12

TEMPORARY HEAD, THROUGH-BOLTED, POSITIONED

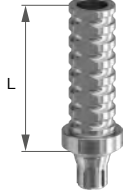

platform (mm)



 ø2,8 ø3,3 ø3,8 ø4,3 ø5,0 ø6,0 ø7,0

head height (L mm)

12

HEALING CAP, NARROW

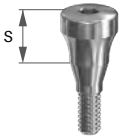

platform (mm)



 ø2,8 ø3,3 ø3,8 ø4,3 ø5,0 ø6,0 ø7,0

sulcus height (S mm)

2 4 6

TEMPORARY HEAD, THROUGH-BOLTED, NON-POSITIONED

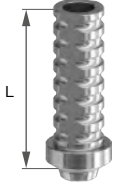

platform (mm)



 ø2,8 ø3,3 ø3,8 ø4,3 ø5,0 ø6,0 ø7,0

head height (L mm)

12

HEALING CAP, ANATOMICAL

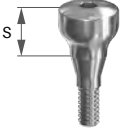

platform (mm)



 ø2,8 ø3,3 ø3,8 ø4,3 ø5,0 ø6,0 ø7,0

sulcus height (S mm)

2 4 6

TEMPORARY HEAD, THROUGH-BOLTED, POSITIONED, PEEK

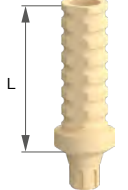

platform (mm)



 ø2,8 ø3,3 ø3,8 ø4,3 ø5,0 ø6,0 ø7,0

head height (L mm)

12

SAMPLING HEAD FOR CLOSED SPOON

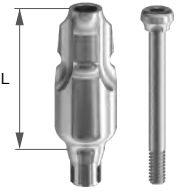

platform (mm)



 ø2,8 ø3,3 ø3,8 ø4,3 ø5,0 ø6,0 ø7,0

head height (L mm)

11

TEMPORARY HEAD, THROUGH-BOLTED, NON-POSITIONED, PEEK

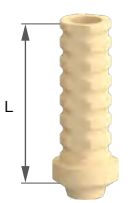

platform (mm)



 ø2,8 ø3,3 ø3,8 ø4,3 ø5,0 ø6,0 ø7,0

head height (L mm)

12

SAMPLING HEAD FOR OPEN SPOON

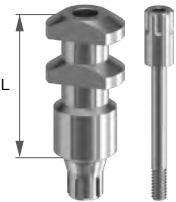

platform (mm)



 ø2,8 ø3,3 ø3,8 ø4,3 ø5,0 ø6,0 ø7,0

head height (L mm)

11

NARROW HEAD, STRAIGHT

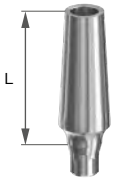

platform (mm)



 ø2,8 ø3,3 ø3,8 ø4,3 ø5,0 ø6,0 ø7,0

head height (L mm)

9

NARROW HEAD, OBLIQUE 15°; 25°

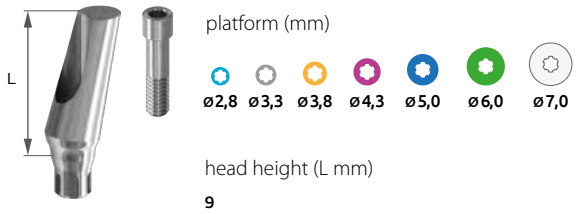

TRAPEZOIDAL HEAD 15°; 25°

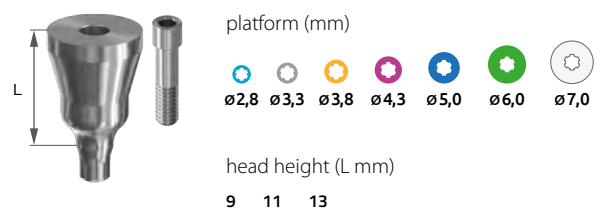

UNIVERSAL HEAD, STRAIGHT

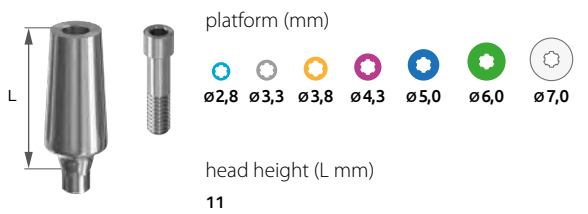

DELTA HEAD 15°; 25°

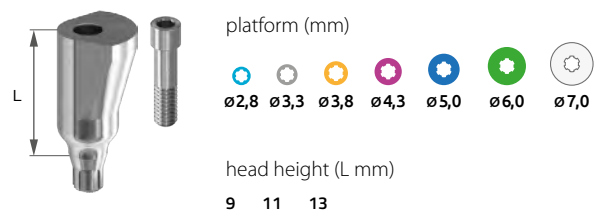

UNIVERSAL HEAD, OBLIQUE 15°; 25°; 35°; 45°

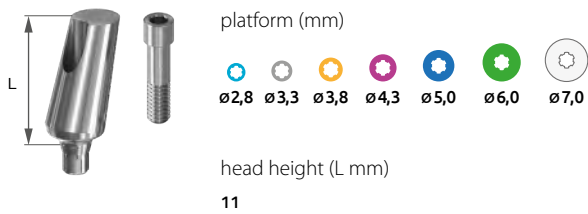

CASTABLE PLASTIC HEAD NARROW, NON-POSITIONED

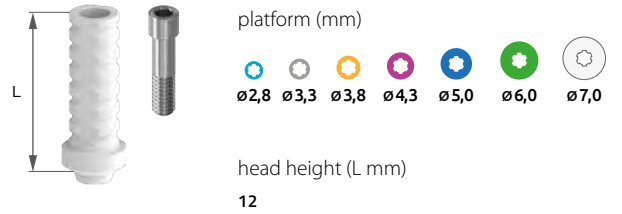

ANATOMICAL HEAD, STRAIGHT

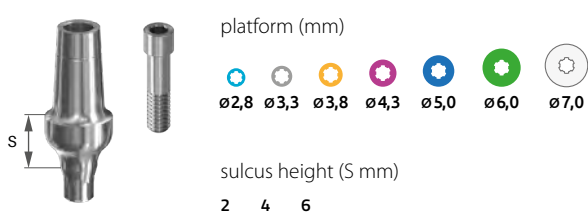

CASTABLE PLASTIC HEAD UNIVERSAL, POSITIONED

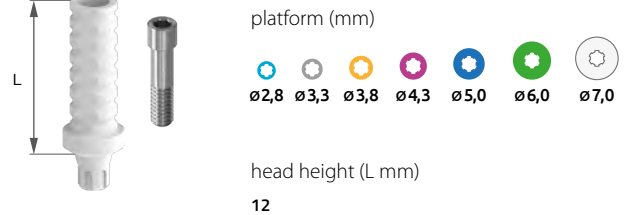

ANATOMICAL HEAD, OBLIQUE 15°; 25°

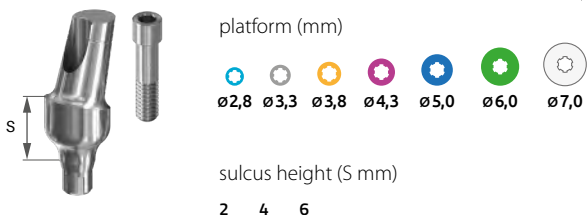

Co-Cr BASED CASTING HEAD, POSITIONED

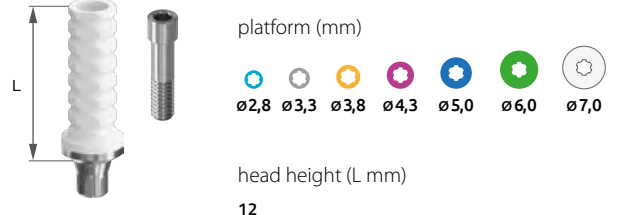





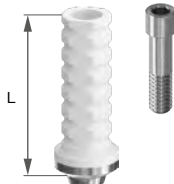

Sizes available of the Scandrea abutments

Co-Cr BASED CASTING HEAD, NON-POSITIONED



platform (mm)





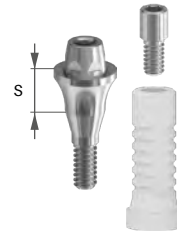

head height (L mm)

12

MULTI-UNIT HEAD, STRAIGHT



platform (mm)







sulcus height (S mm)

0,5 1 2 3 4 5 6 7

INTERFACE, POSITIONED







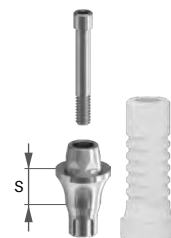

platform (mm)

MULTI-UNIT HEAD, THROUGH-BOLTED



platform (mm)







sulcus height (S mm)

0,5 1 2 3 4 5 6 7

INTERFACE, NON-POSITIONED







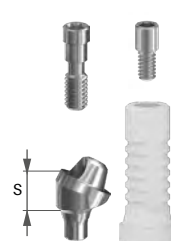

platform (mm)

MULTI-UNIT HEAD OBLIQUE, 20°, 30°



platform (mm)





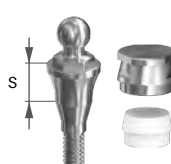

sulcus height (S mm)

0,5 1 2 3 4 5 6 7

BALL-HEAD



platform (mm)







sulcus height (S mm)

0,5 1 2 3 4 5 6 7

MC HEAD OBLIQUE, 20°; 30°



platform (mm)





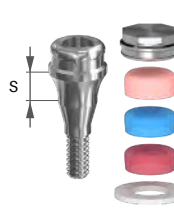

sulcus height (S mm)

1 2 3 4 5 6 7

LOCATOR HEAD, STRAIGHT



platform (mm)







sulcus height (S mm)

0,5 1 2 3 4 5 6 7

MULTI-UNIT SR HEAD, SCREWABLE



platform (mm)

sulcus height (S mm)

0,5 1 2 3 4 5 6 7

MULTI-UNIT SR HEAD, THROUGH-BOLTED

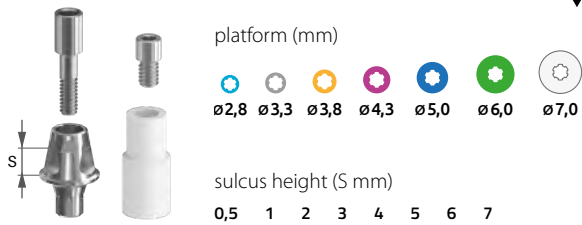

TUBE HEAD, POSITIONED

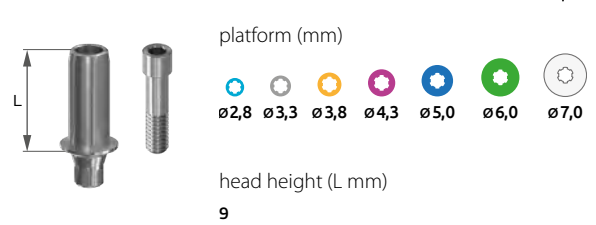

MULTI-UNIT SR HEAD, OBLIQUE 20°; 30°

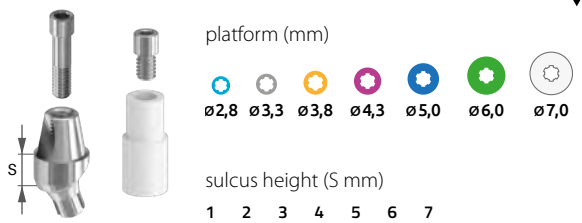

TUBE HEAD, NON-POSITIONED

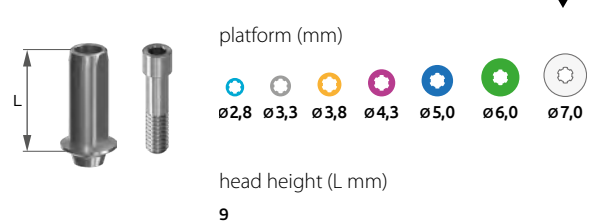

TITANIUM BASE

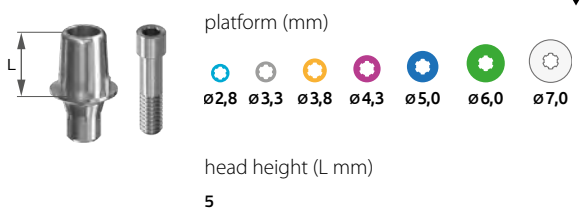

SCANBODY HEAD, THROUGH-BOLTED

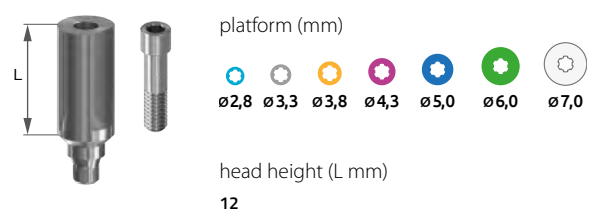

PRESS CERAMIC BEASE

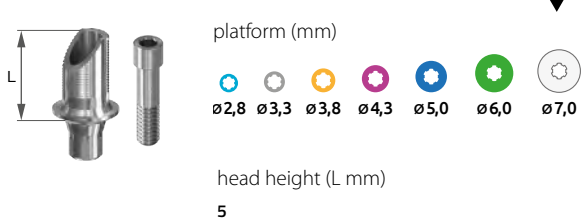

SCANBODY HEAD, SCREWABLE

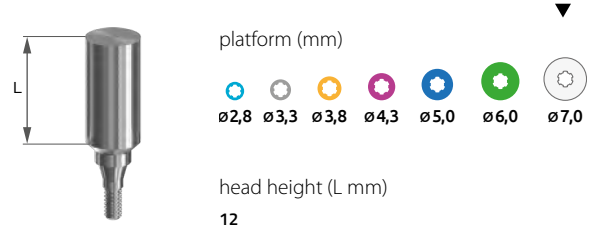

Accessories of the Scandrea abutments

HEADS CREW, SURGICAL



platform (mm)



MULTI-UNIT CUP SCREW



platform (mm)



SAMPLING HEAD SCREW, FOR CLOSED SPOON



platform (mm)



SR-HEAD SCREW



platform (mm)



It is the same in every diameter

SAMPLING HEAD SCREW, FOR OPEN SPOON



platform (mm)



SR-THROUGH-BOLT



platform (mm)



MULTI-UNIT HEAD SCREW



platform (mm)



It is the same in every diameter

INTERFACE SCREW



platform (mm)



It is the same in every diameter

MULTI-UNIT THROUGH-BOLT



platform (mm)



BALL-HEAD CAP. NORMAL



platform (mm)



 ø2,8 ø3,3 ø3,8 ø4,3 ø5,0 ø6,0 ø7,0

sphere diameter 2,5 mm
It is the same in every diameter

CASTABLE HEAD, PLASTIC



platform (mm)



 ø2,8 ø3,3 ø3,8 ø4,3 ø5,0 ø6,0 ø7,0

It is the same in every diameter

BALL-HEAD CAP. MICRO



platform (mm)



 ø2,8 ø3,3 ø3,8 ø4,3 ø5,0 ø6,0 ø7,0

sphere diameter 1,8 mm
It is the same in every diameter

Co-Cr BASED CASTABLE HEAD



platform (mm)



 ø2,8 ø3,3 ø3,8 ø4,3 ø5,0 ø6,0 ø7,0

It is the same in every diameter

LOCATOR HEAD CAP SET



pink cap:
10-20° deviations, 3lbs retention

blue cap:
10-20° deviations, 1,5lbs retention

red cap:
20-40° deviations, 1lbs retention

It is the same in every diameter.

CASTABLE HEAD FOR SR-HEAD



platform (mm)



 ø2,8 ø3,3 ø3,8 ø4,3 ø5,0 ø6,0 ø7,0

It is the same in every diameter

INTERFACE PLASTIC



platform (mm)



 ø2,8 ø3,3 ø3,8 ø4,3 ø5,0 ø6,0 ø7,0

It is the same in every diameter

Co-Cr BASED CASTABLE HEAD FOR SR-HEAD



platform (mm)



 ø2,8 ø3,3 ø3,8 ø4,3 ø5,0 ø6,0 ø7,0

It is the same in every diameter



The products in the publication are only illustrations, they do not cover the exact appearance and shape of the product.



SCANDREA
IMPLANT SYSTEM

INSTRUMENT KIT

SCANDREA Instrument kit

Our instrument kits consist of the inevitable instruments for dental implantation. The Scandrea Large Instrument Kit includes 14 instruments, in a wide range of sizes in order to get versatile utilization. The instrument kit consists of 37 instruments all together.

The instrument trays are built up according to the surgical technique order, labelling and arrowing make their use easier.



SCANDREA Instrument kit

The plate is also suitable for sterilizing the instruments. The sterilizing can be done separately, as the plate can be up-lifted from the box, or together with the box.



SCANDREA Instrument kit

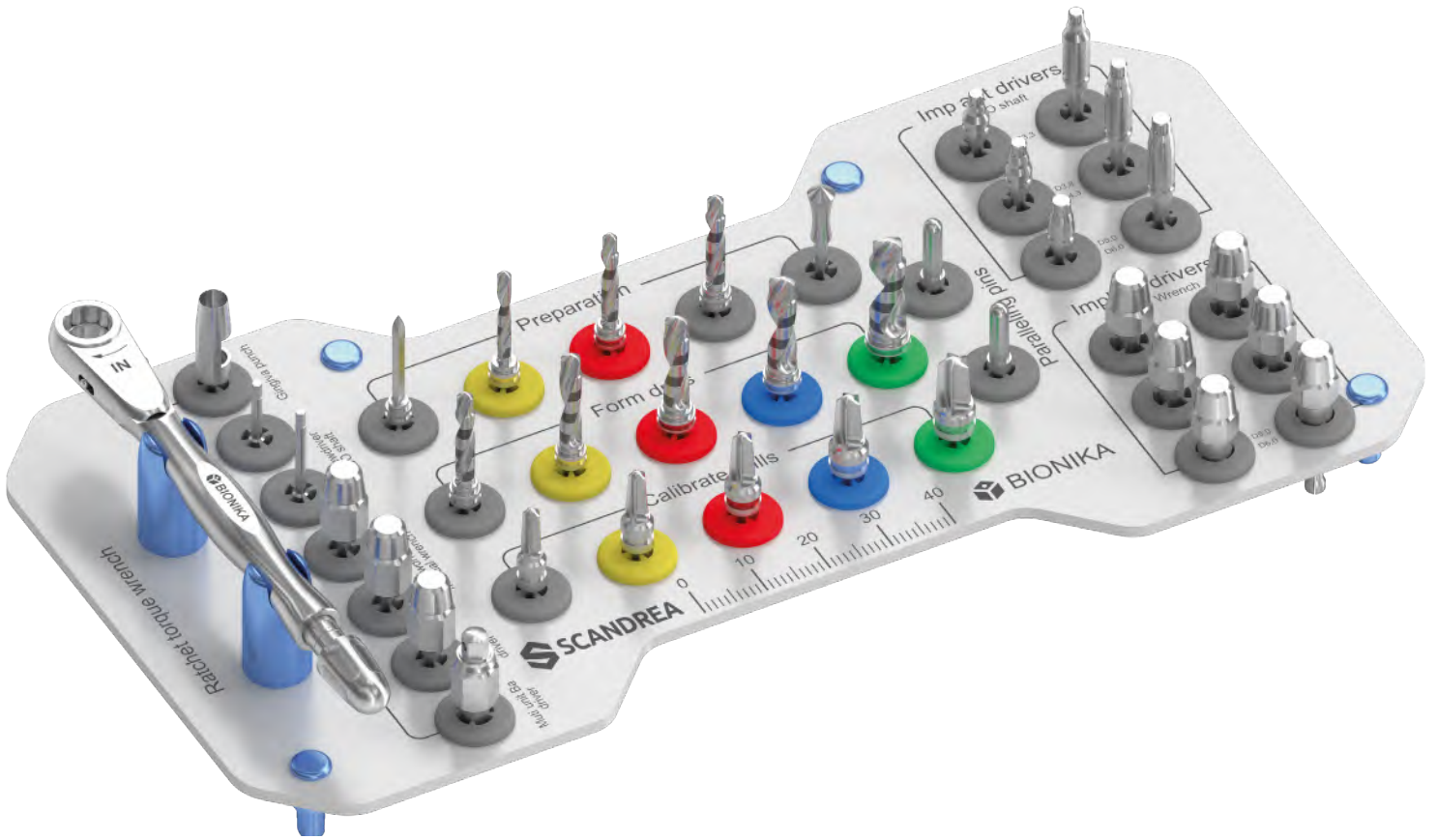

The layout of the Scandrea instrument kit

SCANDREA Instrument kit

- 1 Spear-pointed drill ▼



- 10 Implant driver, mechanical ▼
D3,8-D4,3xL12



- 19 Gingiva punch Ø4,0xL15 ▼



- 2 Pre-drills ▼



- 11 Implant driver, mechanical ▼
D5,0-D6,0xL6



- 20 Head wrench, mechanical ▼
6Lt1,27xL10



- 3 Depth gauge ▼



- 12 Implant driver, mechanical ▼
D5,0-D6,0xL12



- 21 Head wrench, mechanical ▼
6Lt1,27xL15



- 4 Core drills ▼



- 13 Implant driver, manual ▼
D3,3xL6



- 22 Head wrench, manual ▼
6Lt1,27xL10



- 5 Thread groove calibrating drills ▼



- 14 Implant driver, manual ▼
D3,3xL12



- 23 Head wrench, manual ▼
6Lt1,27xL15



- 6 Indicators ▼



- 15 Implant driver, manual ▼
D3,8-D4,3xL6



- 24 Locator key ▼



- 7 Implant driver, mechanical ▼
D3,3xL6



- 16 Implant driver, manual ▼
D3,8-D4,3xL12



- 25 Multi-unit/Ball head key ▼
6Lt2,7



- 8 Implant driver, mechanical ▼
D3,3xL12



- 17 Implant driver, manual ▼
D5,0-D6,0xL6



- 26 Ratchet torque wrench ▼



- 9 Implant driver, mechanical ▼
D3,8-D4,3xL6



- 18 Implant driver, manual ▼
D5,0-D6,0xL12



SCANDREA Surgical drills

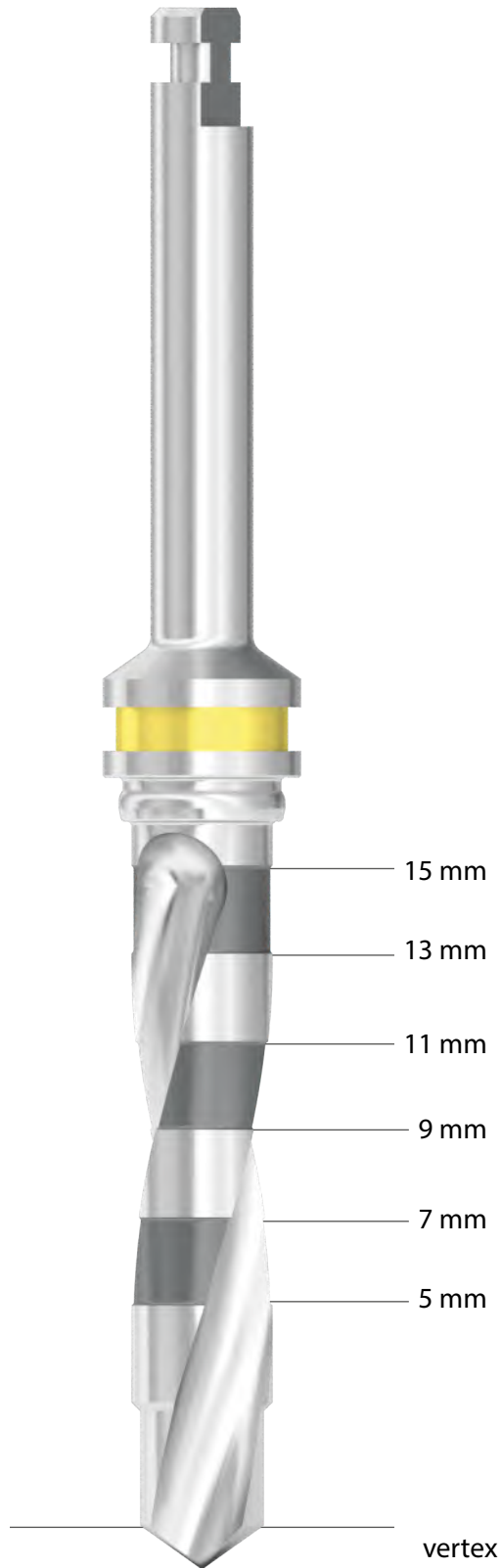

The **BIONIKA drills** - which can be used during implant insertion - are available in a wide range of sizes (compatible with different instrument kits to provide you with the most economical solution).

Our drills are externally cooled and have bone collecting properties. Acidic alloy steel and excellent sharpness guarantee long-term use. Each drill is provided with the required drilling depths. Diameters are indicated by color codes.

Core drills are suitable for preparing implant nests. They are recommended for use according to the drilling protocol, in the case of softer and harder bone structure.

The **Thread Calibrator Drills** are suitable for expanding the implant nests as needed, so that we can extend the upper third of the bone nest. They are recommended to use in the case of harder than average bone structure.

Sizes available of the surgical drills in the instrument kit

SPEAR-POINTED DRILL



BALL-END MILL



PRE-DRILL Ø2,0 mm



PRE-DRILL Ø2,5 mm



CORE DRILL Ø2,8 mm



THREAD GROOVE CALIBRATING DRILL Ø3,2 mm



CORE DRILL Ø3,2 mm



THREAD GROOVE CALIBRATING DRILL Ø3,7 mm



CORE DRILL Ø3,7 mm



THREAD GROOVE CALIBRATING DRILL Ø4,3 mm



CORE DRILL Ø4,2 mm



THREAD GROOVE CALIBRATING DRILL Ø5,0 mm



CORE DRILL Ø5,2 mm



THREAD GROOVE CALIBRATING DRILL Ø6,0 mm



Ratchet torque wrench

The ratchet torque wrench is used to tighten and insert screws and implants. Using pre-set torque, this prevents the implant from fracturing and ensures the optimum power transfer when inserting the implant. The scale of the torque rates from 15 to 35 Ncm. The desired torques can be adjusted from 15 Ncm to the right for the desired scale.

When the ratchet torque wrench adjuster screw bolted to the stop, the wrench of the torque can be infinite, so it can also be used to produce a much greater torque than the torque shown on the scale, as needed.

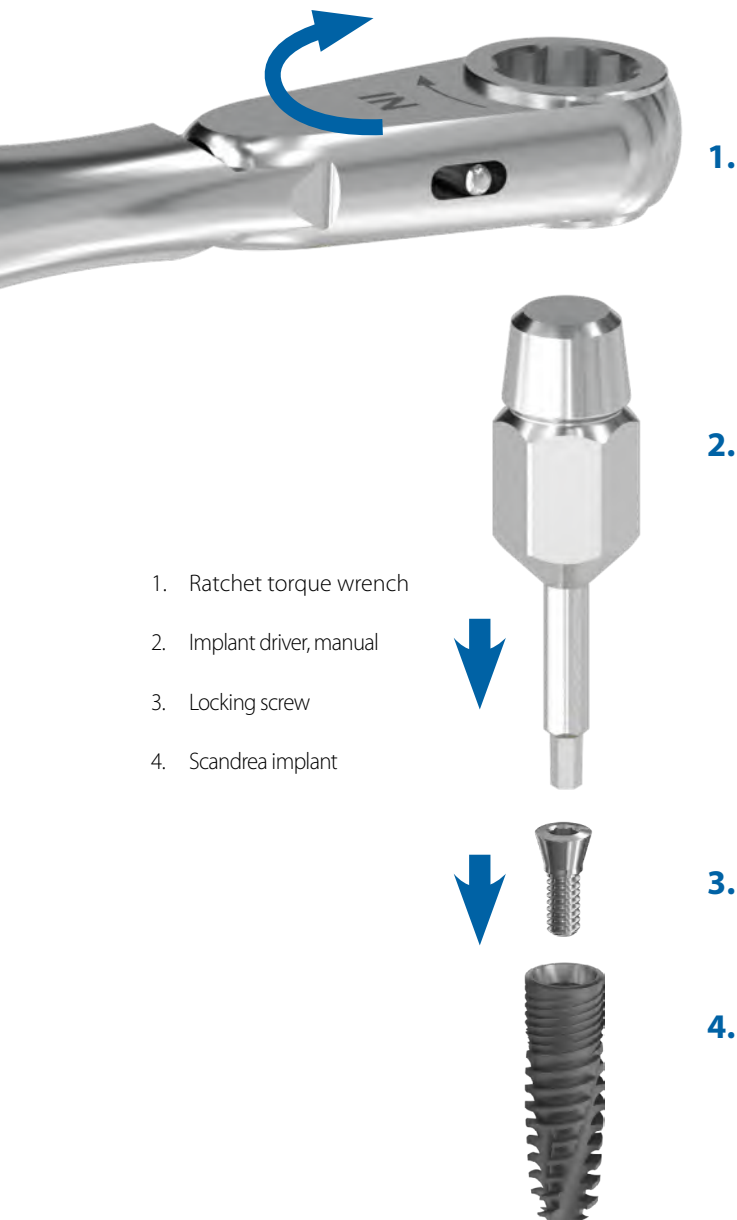

1. Ratchet torque wrench
2. Implant driver, manual
3. Locking screw
4. Scandrea implant





















- ERGONOMIC CONSTRUCTION
- RELIABLE LIFETIME
- PRECISE TORQUE CONTROL
- STAINLESS STEEL
- SOUND SIGNAL
- REPLACABLE KEY INTERLINE
- STABLE TORQUE SCALE DURING USE
- PROFESSIONAL QUALITY

- 15 Ncm
- 25 Ncm
- 35 Ncm
- endless torque

The desired torques can be adjusted from 15 Ncm to the right.

Applications of Ratchet torque wrench



Heads and Screws	Key Interline	Torque
Locking screw		
Healing cap		
Sampling head screw for closed and open spoon		
Sampling head for closed and open spoon		
Head screw		
Universal head, straight		
Universal head, oblique		
Anatomical head, straight		
Anatomical head, oblique		
Titanium base		
Multi-unit head, through-bolted		
Multi-unit head screw, SR-head screw		
Multi-unit head, screwable		
SR-head, screwable		
Ball-head		
Locator head		

Manual key driver
10-15 Ncm

Ratchet torque wrench

Torque of the required screw tightening:

In the case of M1,4 screw it is 15 Ncm

In the case of M1,6 screw it is 20 Ncm

In the case of M1,8 screw it is 25 Ncm

In the case of M2,0 screw it is 30 Ncm



Get to know our other products!

Ask for our catalogs or visit one of our websites below:



www.bionika.hu



www.shop.bionika.hu

